

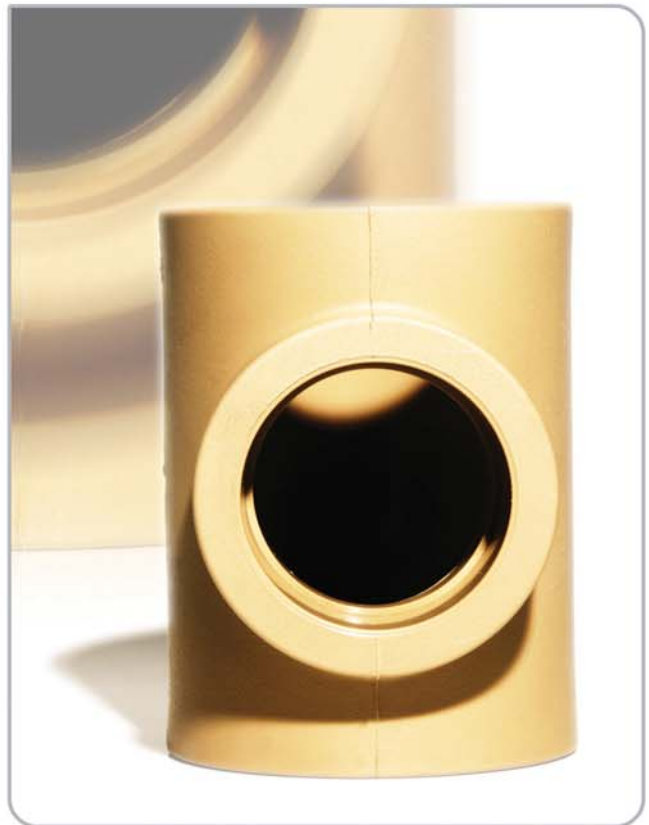

AQUASYSTEM[®]

**The PP-R piping systems
for hot and cold water
and for heating**

The system for the life

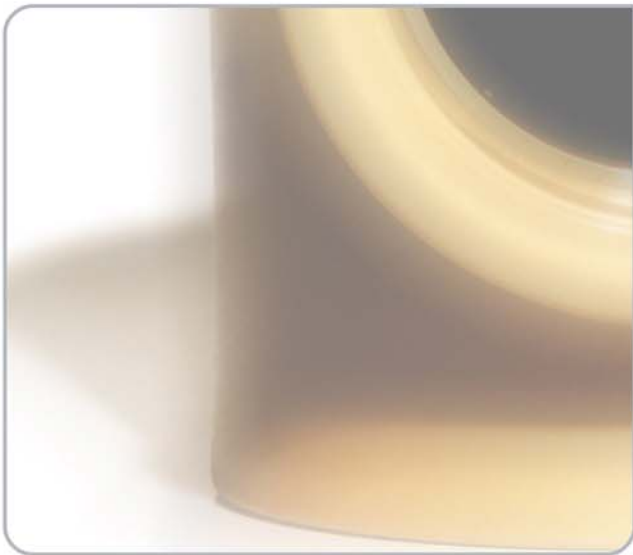

Contents

1. Introduction	4
2. PP-R: the characteristics of the material	5
3. Application range	6
4. Main features of the George Fischer PP-R piping system	6
4a. Outstanding features of the AQUASYSTEM	6
4b. Outstanding features of the +GF+ PP-R/ALU/PP-R	7
5. General precautions	9
6. Pipe dimension	11
6.1 Pipe selection	11
6.2 Pressure losses	12
6.3 Regression curves (over-time duration)	15
6.4 Thermal expansion	17
6.4.1 Calculation of the thermal expansion	17
6.4.2 Positioning of the flexible arms	19
6.4.3 Installation layout	20
6.4.5 Pipe brackets	20
7. Instruction for the socket fusion	21
7.1 Preparation	21
7.2 Fusion	22
8. Electrofusion	23
9. Hole repairing	24
10. Instruction for the welding saddle	25
11. Product range	27
12. Standards and approvals	46

AQUASYSTEM® trademark Georg Fischer S.p.A.

The technical data given in this publication are for general information purposes only. They imply no warranty of whatever kind. Please consult our General Conditions of Supply.

1. Introduction

Water services in buildings are complex, requiring both experience and careful material selection.

The goal is to design and produce a piping system for hot and cold water supply that is easy to use and assembly. All components are fully integrated and sturdy, whilst maintaining a low price.

George Fischer is a leader producer of pipe fittings made of various materials since 1858.

In the field of thermoplastic materials, George Fischer is considered to be a pioneer, as well as one of the best known producers, utilising the most advanced technology in the world.

The test laboratory is one of the most famous in the world in the field of plastic materials, and it is completely dedicated to research, development and testing of new products. The equipment and instruments used are the most modern and up-to-date on the market today, this makes it possible to carry out the most sophisticated tests.

This all comes together with the highest standard of technology, production and logistics, which contributes to guaranteeing the best product for the end users:

- **quality**
- **experience**
- **reliability**

2. PP-R: the characteristics of the material

Pipes and fittings are made of Polypropylene Random, also known as type 3. The quality of our material can guarantee a long life (50 years), high resistance to pressure and temperature. This material is suitable for hot and cold water and heating systems.

The special properties of the material, compared to the other materials, give the following advantages

- **high dimensional stability (when hot)**
- **maximum resilience**

Sound reduction index of the most common building materials

Properties	ISO	DIN	Unit	Values
Flow index	ISO 1133	DIN 53735		
MFI 190/5	Procedure 180	Code T	g/10 min	0,4
MFI 230/2,16	Procedure 12	Code M	g/10 min	0,25
MFI 230/5	Procedure 20	Code V	g/10 min	1,25
Density a 23°C	ISO/R 1183	DIN 53479	g/cm ³	0,90-0,91
Resilience (Charpy)				
23°C	ISO 179/2D	DIN 53479	kJ/ m ²	n.r.
-30°C	ISO 179/2D	normal scale	kJ/ m ²	40
Chipping resilience (notch-engraved sample test)				
23°C	ISO 179/2C	DIN 53453	kJ/ m ²	25
-30°C	ISO 179/2C	normal scale	kJ/ m ²	2,5
Resilience (Izod)				
23°C	ISO 180/1C	-	kJ/ m ²	n.r.
-30°C	ISO 180/1C	-	kJ/ m ²	28
Scratching resilience (engraved sample test) (Izod)				
23°C	ISO 180/1A	-	kJ/ m ²	23
-30°C	ISO 180/1A	-	kJ/ m ²	2,5
23°C	ASTM D 256	-	kJ/ m ²	27
-30°C	ASTM D 256	-	kJ/ m ²	4
Traction test				
Yield test	ISO 527	DIN 53455	N/mm ²	27
Yield Elasticity	Forwarding speed	Forwarding speed	%	11
Breakage Elongation	-		%	> 800
Traction Module E	ISO 527	DIN 53457	N/mm ²	900
Elasticity yield to tangental tension	ISO/R 537Metod A.	DIN 53445	N/mm ²	450
Bending stress 3.5%	ISO 178 standard test 5.1	DIN 53452	N/mm ²	24
Brinell hardness test	ISO 2039 (H358/30)	DIN 53456 (H358/30)	N/mm ²	49
VICAT A/°C Melting point	ISO 306	DIN 53460	°C	135-145
Dimensional heat stability °C	ISO 75/B	DIN 53461	°C	75
Surface Resistance		DIN 53482	Ω	>10 ¹³
Mass resistivity		DIN 53482	Ω cm	>10 ¹⁶
Dielectric loss angle (tg.) (10 ⁴ Hz)		DIN 53483	-	2 x 10 ⁻⁴
Relative dielectric constant (10 ⁴ Hz)		DIN 53483	-	2,3
Dielectric rigidity		ASTM D149	kV/mm	75
Termal conductivity at 20° C	VDE 0304 (1-4)	52612	W/mK	0,22
Termal expansion factor			mm/m°C	0,15
Specific heat 20°C			Kj/KgK	2,0

The above characteristics are the results of the tests on extruded samples after 96 hours storage at normal room conditions 23/50 (2) DIN 50014 and represent indicative values.

3. Application range

The PP-R AQUASYSTEM is particularly suitable for hot and cold water installation: residential building, office, hotel, new installation and renovation. The wide range of pipes and fittings, from 20 to 110 mm, is suitable for any kind of installation.

AQUASYSTEM is recommended for the following installations:

- **sanitary & plumbing**
- **heating**
- **air conditioning**
- **food industry**
- **compressed air**

4a. Outstanding features of the AQUASYSTEM

Some of the best advantages offered by the AQUASYSTEM®, in comparison with traditional systems, are as illustrated below:

Reduced installation time

Compared with traditional systems, AQUASYSTEM® can grant a reduction in installation time of at least 30%.

Resistance to electrolysis

The high resistivity of the piping system (10 Ohm cm.) guarantees a very low electrical conductivity. The risk of PP-R pipe or fittings piercing due to stray currents is practically nothing. Most chemical substances, which might be present in water or concrete, do not attack PP-R; in cases where special substances are being used, please contact Georg Fischer for advice.

Pipes and fitting pressure losses

The inner surface of pipes and fittings have a very low frictional resistance, in comparison to traditional systems, thus making it possible to reduce the distribution pressure losses (see diagram on the following page) .

No Scaling

The reduction of the water flow normally occurs as a consequence of scaling (calcium carbonate) especially at high temperatures. PP-R pipes of the Georg Fischer system do not have scaling problems.

Low Thermal Conductivity

The thermal conductivity of PP-R is very low, thus making it possible to reduce heat losses in the hot water supply and traditional heating systems. This does not remove the statutory requirements for insulation on pipework, but can improve the effect of insulation.

Long Life

The Georg Fischer piping system for hot and cold water services under pressure, is designed to guarantee over 50 years operation at pressure and temperature conditions listed in the following tables (regression curves).

Non-toxicity and Safety

All materials used in the Georg Fischer supply system, which are in contact with water, are certified as non-toxic and suitable for contact with drinking water.

Resistance against abrasion

Compared with traditional systems, AQUASYSTEM assures a very high resistance against abrasion granting in this way a long life.

Noise Reduction

The material used has a high sound reduction index for absorbing sound waves and limiting the spread through pipes.

4b. Outstanding features of the +GF+ PP-R/ALU/PP-R

The multilayer pipe PP-R/ALU/PP-R is an extension range of AQUASYSTEM with better workability and lower thermal expansion.

This system is working with the special PP-R ALU pipe and the traditional PP-R fittings.

The PP-R ALU pipe are extruded on three different layer: the main pipe is made of PP-R, coated with an aluminium foil, then covered with a PP-R film treated to resist long time against UV light.

It's allowed expose the pipe to direct UV light, outside the buildings.

The aluminium foil protect the inside PP-R pipe preserving its features and acting as a barrier to the oxygen.

This pipe can be bent and remain into desired position. Moreover the aluminium foil strengthen the pipe and permit bigger distance between the brackets.

In addition to the normal features, PP-R ALU pipe has the following characteristic:

- **lower thermal expansion**
 $\alpha = 0,03 \text{ mm/mK}$
- **better workability**
- **better resistance to knocks**
- **resistance to UV ray**
- **impermeability to oxigen**



Sound reduction in sanitary installation

For an efficient noise reduction, the recommendations below should be considered.

It is very important to take the necessary preventive measures for noise reduction. Therefore a precise design needs to be done in advance. Careful planning of piping system is necessary to optimise noise reduction.

Pipe sizing and the design of the distribution system is important, as well as the selection of fittings and taps used. The walls, to which the pipes, the taps and other fittings are fixed to, must have a weight coefficient of 220 kg/m². The most important measure for efficient noise reduction in the water supply system, is the use of taps with a noise level less than 20 db (A) in compliance with DIN 52218.

Sound reduction index of the most common building materials

Type of stone or tile Description	Wall thickness cm	Specific density of stone or tile kg/m ³	Weight of surface with mortar, without plaster kg/m ²	Approx sound reduction index in dB ²	Weight of plastered surface 1x1,5 cm kg/m ²	Approx sound reduction index in dB ²	Weight of plastered surface 2x1,5 cm kg/m ²	Approx sound reduction index in dB ²
Full bricks made of pumice and inflated clay (Liapor)	9,5	1100	104,5	37	119,5	38	134,5	40
	11,5		126,5	39	141,5	40	156,5	41
	17,5		192,5	44	207,5	44	222,5	45
	24,0		264,0	47	279,0	48	294,0	49
Full bricks made of pumice and inflated clay (Liapor)	30,0	1100	330,0	50	345,0	50	360,0	51
	17,5		192,5	44	207,5	44	222,5	45
	24,0		264,0	47	279,0	48	294,0	49
	30,0		330,0	50	345,0	50	360,0	51
Vertical pierced tiles (small size)	36,5	1400	401,5	52	416,5	53	431,5	53
	11,5		161,0	42	176,0	43	191,0	44
	17,5		245,0	46	260,0	47	275,0	48
	24,0		336,0	50	351,0	51	366,0	51
Light tiles (large size)	30,0	1200	420,0	53	435,0	53	450,0	54
	11,5		138,5	40	153,0	41	168,0	42
	17,5		210,0	45	225,0	45	240,0	46
	24,0		288,0	48	303,0	49	318,0	50
Porous tiles, for instance Paraton, Unipor, Pari Klimaton	30,0	1000	360,0	51	375,0	51	390,0	52
	11,5		115,0	38	130,0	39	145,0	40
	17,5		175,0	43	190,0	44	205,0	44
	24,0		240,0	46	255,0	47	270,0	48
Gabeton tiles, for instance Ytong, Hebel	30,0	800	300,0	49	315,0	49	330,0	60
	10,0		80,0	33	95,0	36	110,0	37
	12,5		100,0	36	115,0	38	130,0	39
	15,0		120,0	38	135,0	40	150,0	41
	20,0		160,0	42	175,0	43	190,0	44
	25,0		200,0	44	215,0	45	230,0	46
Gabeton sandstone, gabeton full	30,0	1750	240,0	46	255,0	47	270,0	48
	36,0		292,0	48	307,0	49	322,0	50
	11,5		201,0	44	216,0	45	231,0	46
	17,5		306,0	49	321,0	50	336,0	50
Pierced tiles	24,0	1500	420,0	53	435,0	53	450,0	54
	30,0		525,0	55	540,0	56	555,0	56
	11,5		172,5	42	187,5	43	202,5	44
	17,5		262,5	47	277,5	48	292,5	48
	24,0		360,0	51	375,0	51	390,0	52
Full bricks	30,0	1800	450,0	54	465,0	54	480,0	54
	36,0		547,5	56	562,5	56	577,5	56
	11,5		207,0	44	222,0	45	237,0	46
Concrete	10,0	2350	235,0	46				

5. General precautions

UV Ray

Like all plastic materials, PP-R even though UV Ray stabilised, must not be exposed to the sun.

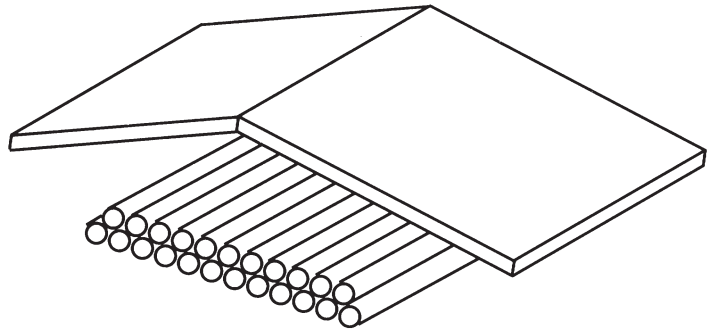

Low Temperatures

With temperatures close to zero, the material becomes brittle, therefore it is recommended to avoid possible knocks to the piping. Should it be possible for the water to freeze whilst in the pipes, it is recommended that the pipes be emptied, since a volume increase could lead to breakages.

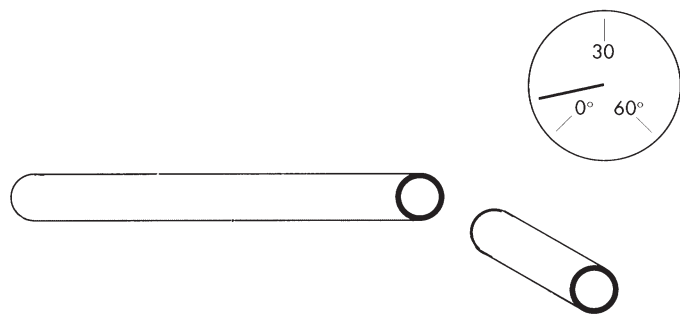

We suggest to cut the pipe end of 5 cm.

Water Tightness with other Metal Fittings

It is recommended not to join PP-R materials with conical or not suitable fittings. The metal fittings are in special brass. The thread is made with high precision therefore easy to tighten. Where it is necessary to join to metal, the use of teflon or PARALIQ PN35 tape is recommended.

PARALIQ tape is quick and sure and above-all is according to the DVGW/ÖVGW/SSIGA water and gas standards.

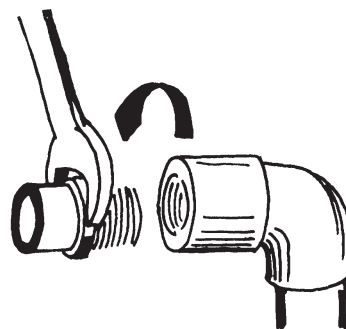

Pipes Bending

The minimum bending radius must be equal to 8 times the pipe diameter. For this purpose, heat the part which will be bent by using a hair-dryer or suitable equipment.

Do not use flame.

To bend the PP-R ALU pipe do not warm it.

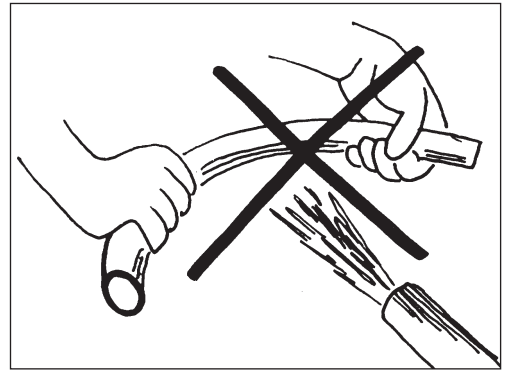

Transport and Storage

Here below we give a few hints for material transport and storage.

Wrong

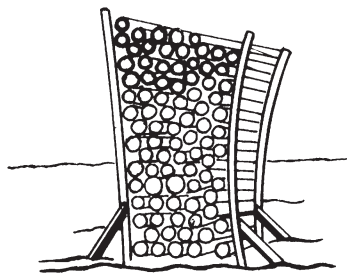
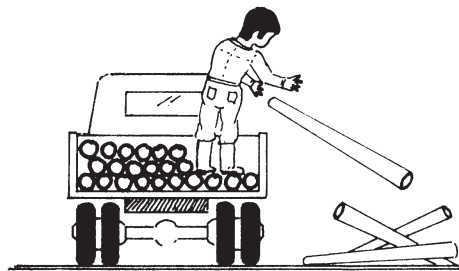
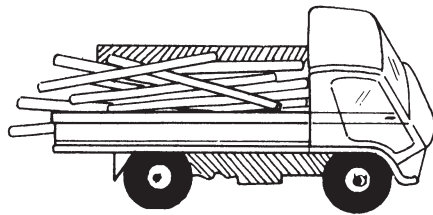

Right

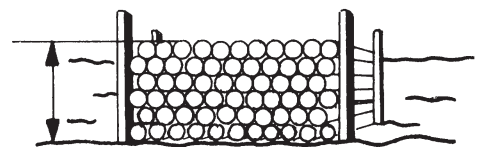
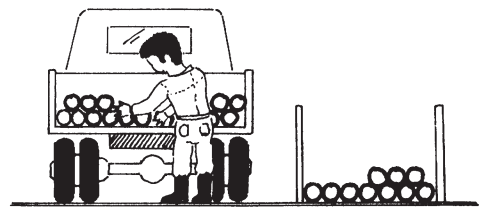
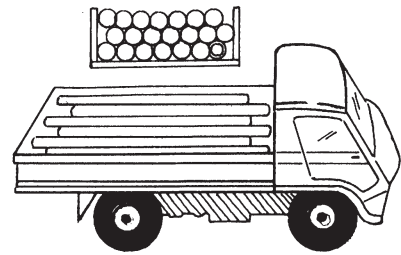

6. Pipe dimension

6.1 Pipe Selection

In order to select the best water flow depending on the available water pressure and corresponding usage, please refer to the table here below:

Table for the selection of pipe diameters and water flow

Water Connection Point	Flow (l/sec).	Pressure (bar)	Pipe Diameter (mm)
Wash-Basin			
Tap DN 15	0,07	0,50	20
Mixer Tap DN 15	0,07	1,00	20
Bidet			
Tap DN 15	0,07	0,50	20
Mixer Tap DN 15	0,07	1,00	20
Bath tub			
Mixer Tap DN 15	0,15	1,00	20
Mixer Tap DN 20	0,40	1,00	25
Mixer Tap DN 25	1,00	1,00	32
Shower			
Sprinkler DN 15	0,15	1,00	20
Sprinkler DN 15	0,06	1,00	20
Sprinkler DN 20	0,18	1,00	20
Sprinkler DN 25	0,31	1,00	20
Flush and flushing tank			
Flush DN 20	1,00	1,20	32
Flush Tank DN 15	0,13	0,50	20
Electric and gas Boilers			
6 kW	0,07	1,00	20
12 kW	0,10	1,00	20
18 kW	0,15	1,00	20
21 kW	0,17	1,00	20
24 kW	0,20	1,00	20
33 kW	0,30	1,00	20
Sinks			
Mixer DN 15	0,07	1,00	20
Mixer DN 20	0,02	1,00	20
Dishwashers			
Washing Machines			
Urinals			
Flush DN 15	0,30	1,20	20
Flushing Tank DN 15	0,13	0,50	20

6.2 Pressure losses

The pressure losses for distribution in the George Fischer piping system can be assessed by means of the following chart or by means of the following formula:

$$\Delta p = \lambda \cdot \frac{L \cdot \rho \cdot v^2}{d_i \cdot 2 \cdot 10^2}$$

Loss pressure diagram for PN20 pipe

where: Δp pressure loss in a straight length of pipe in bar
 λ pipe friction factor
 L length of the straight length of pipe in m
 d_i inside diameter of pipe in mm
 ρ density of transported media in kg/m³
 v flow velocity in m/s

Note: In practice, when making a rough calculation (i.e. smooth plastic pipe and turbulent flow) it is enough to use the value $\lambda = 0.02$ to represent the hydraulic pressure loss.

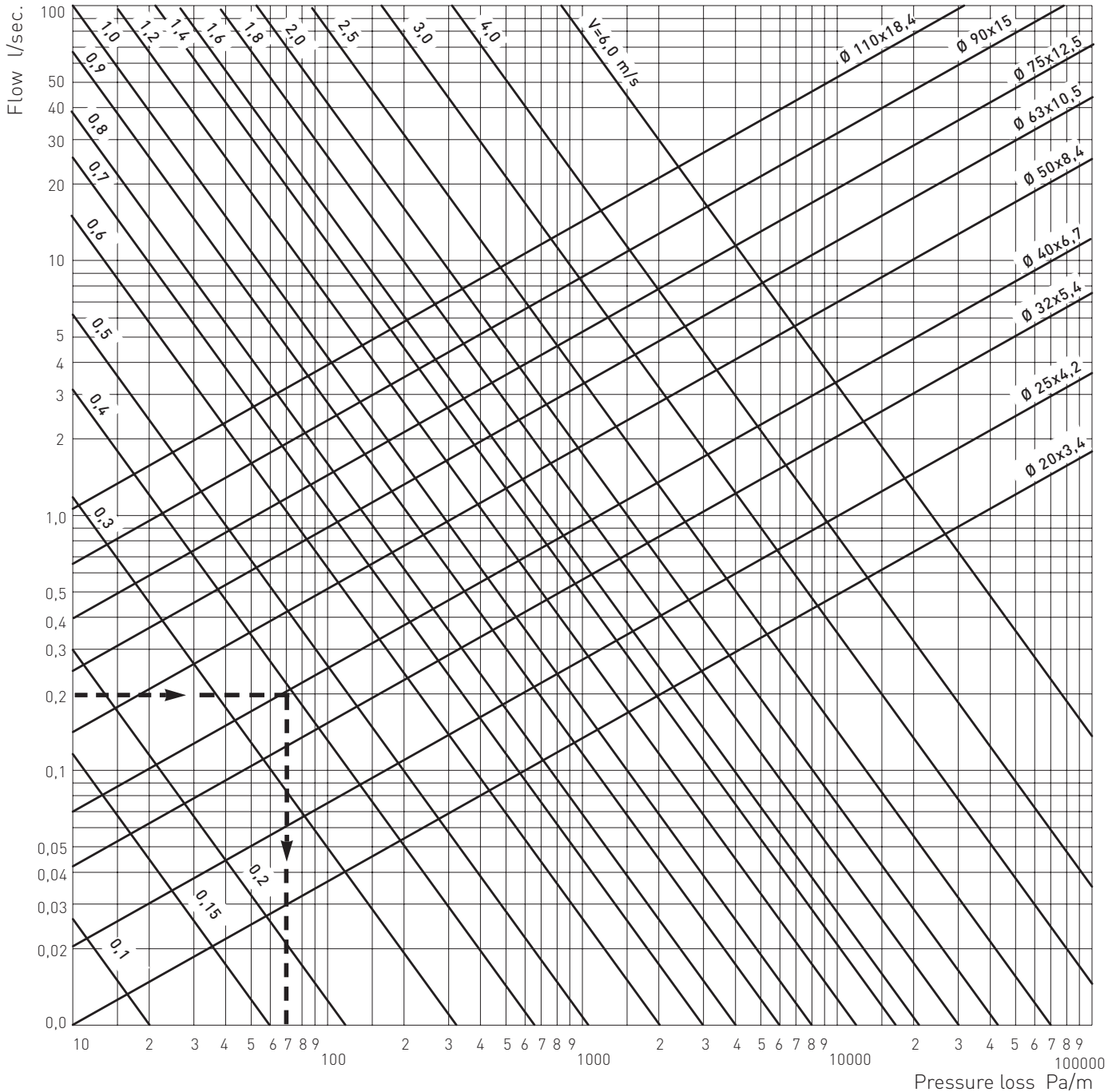

Pressure loss: **Pa/m. (10.000 Pa = 0,1 bar = 100 mbar)**

Example pipe: 40 x 6,7 mm
 flow: 0,2 l/s
 water velocity: 0,4 m/sec.
 pressure loss: 70 Pa/m. = 0,7 mbar

Loss pressure diagram for PN10 pipe

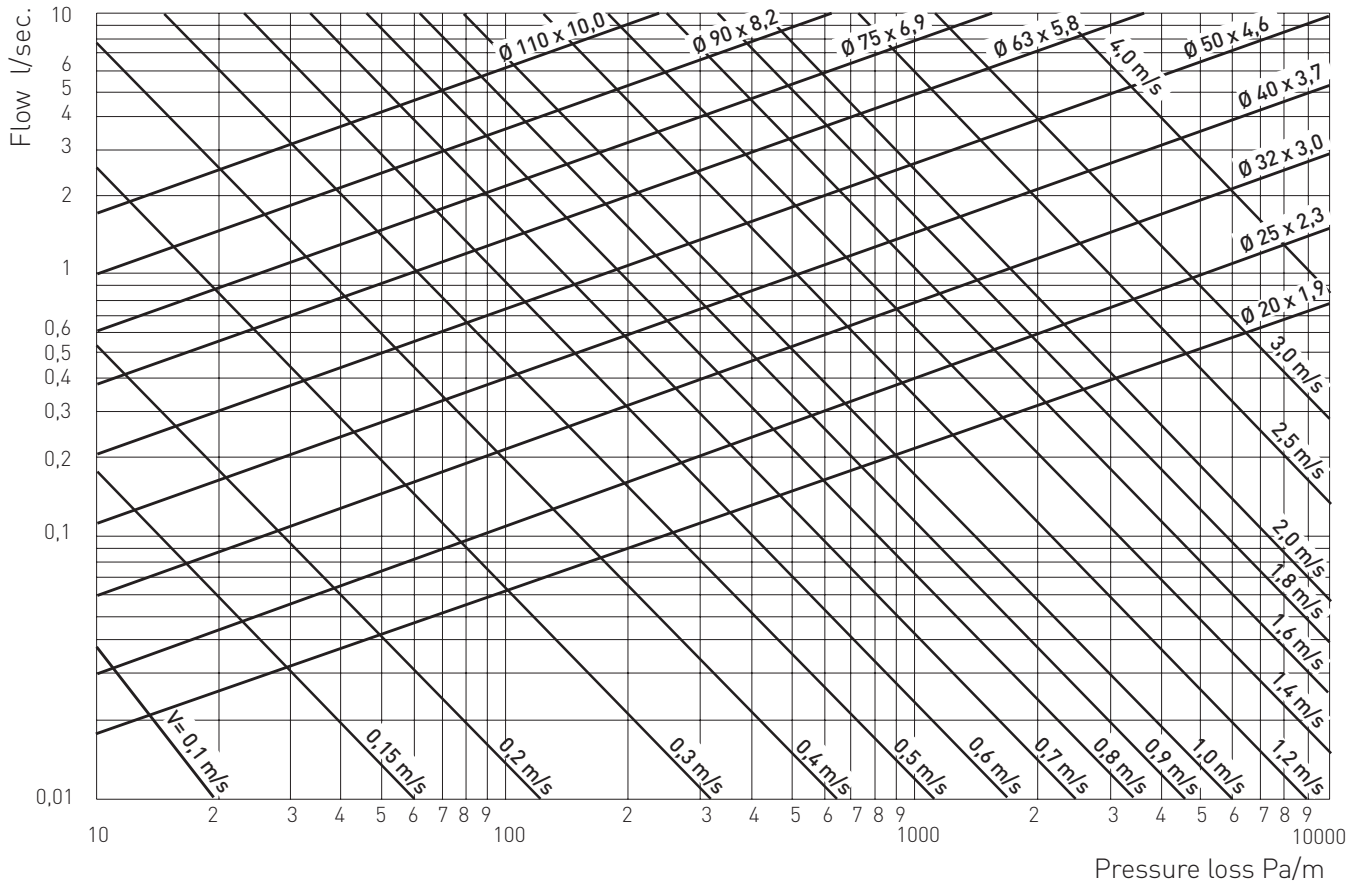

Loss pressure diagram for PP-R ALU pipe (PN16)

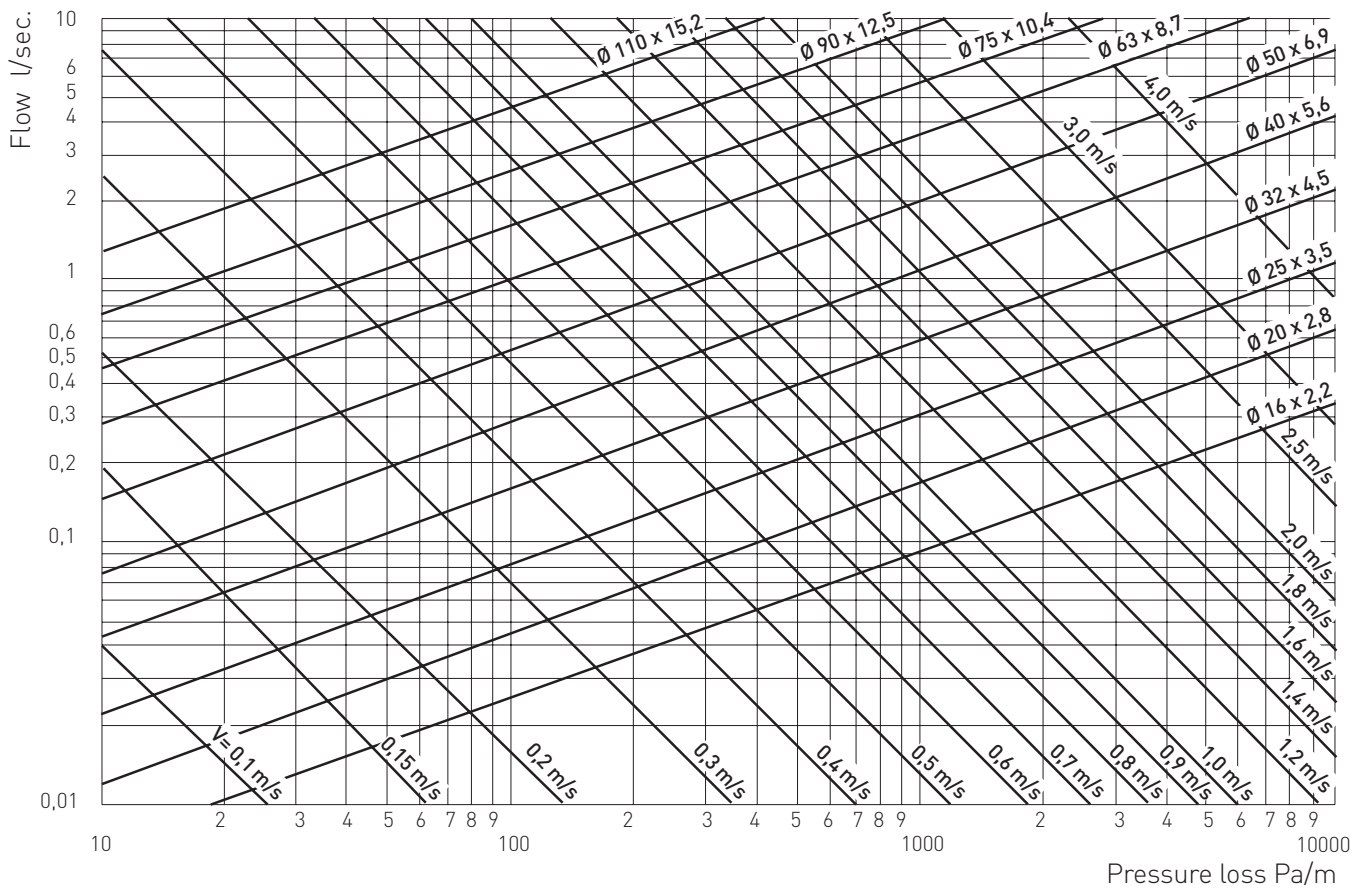



















Table of fittings pressure loss in Georg Fischer fittings

Description	Symbol	Coefficient of resistance
Equal coupling		0,25
Elbow 90°		2,00
Elbow 45°		0,60
Equal tee 90°		1,80
Reduced tee 90°		3,60
Equal tee 90°		1,30
Reduced tee 90°		2,60
Equal tee 90°		4,20
Reduced tee 90°		9,00
Equal tee 90°		2,20
Reduced tee 90°		5,00
Threaded tee 90°, male		0,80
Concentric reductions up to 2 size		0,55
Concentric reductions up to 3 size		0,85
Threaded fitting, male		0,40
Threaded fitting, male, reduced		0,85
Threaded elbow, male		2,20
Threaded elbow, male, reduced		3,50

Calculation Example

Suppose we have a water services system with the following characteristics:

- diameter 25 mm
- total length 10 m
- fittings used:
 - 4 sleeves
 - 3 elbows 90°
 - 2 equal tees
 - 1 threaded coupling, male
- velocity 1,5 m/sec (constant for a simpler calculation)
- flow rate 0,35 ltr/sec
- T = 20 °C

from the table:

- r1 (coupling) = 0,25
- r2 (sleeve 90°) = 2,00
- r3 (equal tees) = 1,80
- r4 (threaded coupling, male) = 0,40

**Total fittings pressure losses:
Distributed losses (chart):**

$$H = 10 \times \frac{11 \times 1,5^2 \times 1000}{2 \times 9,8} = 12630 \text{ Pa} = 126 \text{ mbar}$$

Linear P = 1100 Pa/m
= 11 mbar

Distributed P = 11 x 10
= 110 mbar

Total charge loss:

Total P = H + P_{dist} = 236 mbar

The fittings pressure losses are calculated by the following formula:

$$H = 10 \cdot \Sigma r \cdot v^2 \cdot \gamma / 2g$$

- where: v = water velocity (m/sec)
g = specific gravating of water (kg/m³)
g = 9,8 m/s²
r = coefficient of resistance

6.3. Regression curves (over time duration)

The regression curves affect pipe life depending on the fluid pressure, temperature and outer stress (see chart).

Regression curves RA 130E - 1005

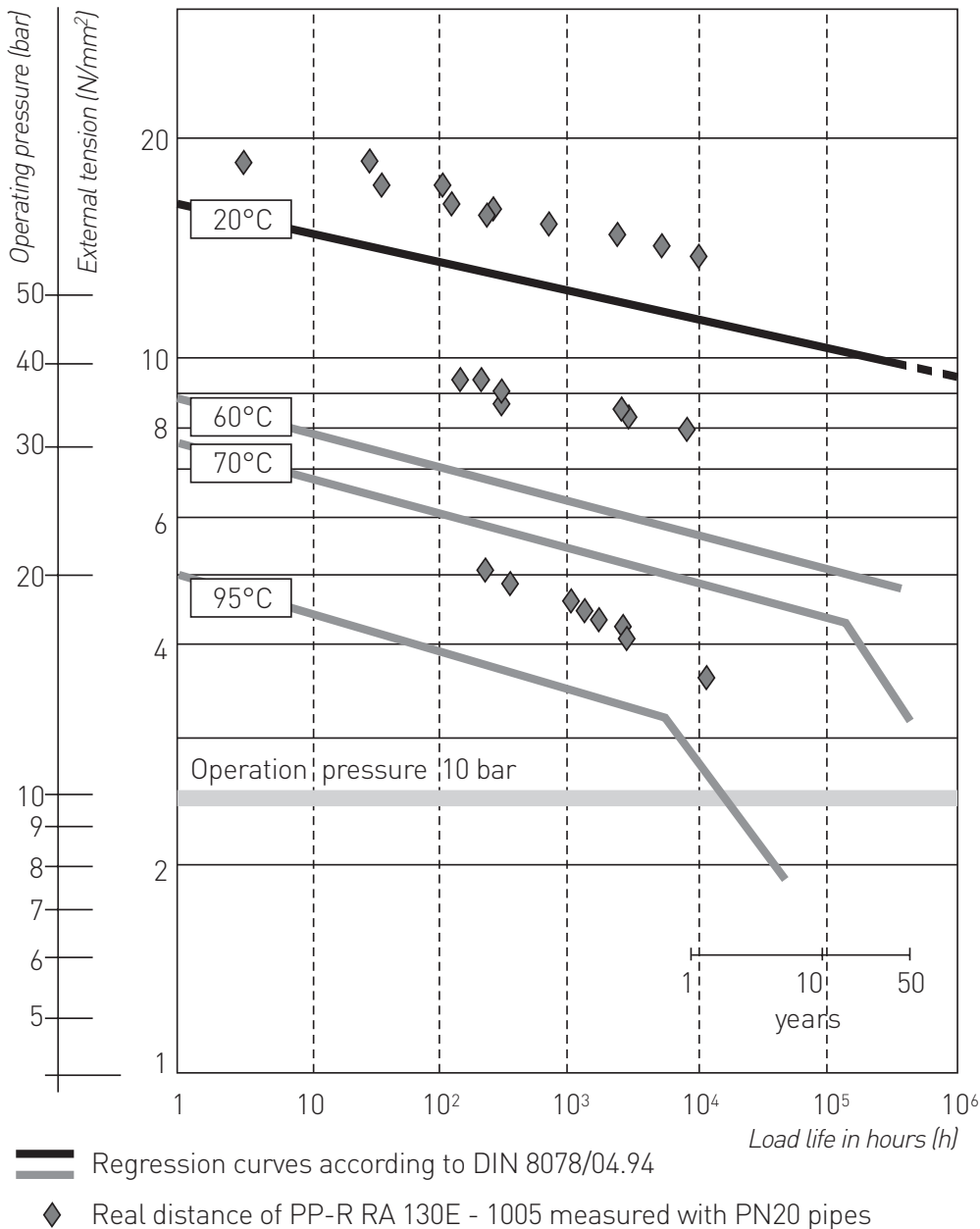

The diagram shows the lowest life features according to DIN 8078 standards and life test results concerning the RA 130E - 1005 polymer produced by Borealis in order to confirm the high resistance to pressure and temperature of AQUASYSTEM®

The formula joining these parameters is:

$$R = P \times \frac{d - s}{2s}$$

P = maximum inner pressure.
 d = outer diameter
 s = thickness
 R = outer stress

Example

$T = 60^\circ\text{C}$

Continuous operating life:

50 years

From the regression curve the result is:

$R = 4,9 \text{ Mpa}$

Calculation (from the formula)

$P = 19,7 \text{ bar}$

Or $P = 13 \text{ bar}$

(using safety coefficient of 1.5)

Working pressure admitted

water temperature	working years	Type of pipe		
		PN 10	PN 16	PN 20*
		SDR 11	SDR 7,4	SDR 6
		S 5	S 3,2	S 2,5
		Pressure bar		
10°C	1	17,6	27,8	35,0
	5	16,6	26,4	33,2
	10	16,1	25,5	32,1
	25	15,6	24,7	31,1
	50	15,2	24,0	30,3
20°C	1	15,0	23,8	30,0
	5	14,1	22,3	28,1
	10	13,7	21,7	27,3
	25	13,3	21,1	26,5
	50	12,9	20,4	25,7
30°C	1	12,8	20,2	25,5
	5	12,0	19,0	23,9
	10	11,6	18,3	23,1
	25	11,2	17,7	22,3
	50	10,9	17,3	21,8
40°C	1	10,8	17,1	21,5
	5	10,1	16,0	20,2
	10	9,8	15,6	19,6
	25	9,4	15,0	18,8
	50	9,2	14,5	18,3
50°C	1	9,2	14,5	18,3
	5	8,5	13,5	17,0
	10	8,2	13,1	16,5
	25	8,0	12,6	15,9
	50	7,7	12,2	15,4
60°C	1	7,7	12,2	15,4
	5	7,2	11,4	14,3
	10	6,9	11,0	13,8
	25	6,7	10,5	13,3
	50	6,4	10,1	12,7
70°C	1	6,5	10,3	13,0
	5	6,0	9,5	11,9
	10	5,9	9,3	11,7
	25	5,1	8,0	10,1
	50	4,3	6,7	8,5
80°C	1	5,5	8,6	10,9
	5	4,8	7,6	9,6
	10	4,0	6,3	8,0
	25	3,2	5,1	6,4
95°C	1	3,9	6,1	7,7
	5	2,5	4,0	5,0

DIN 8077 - coefficient factor 1,5 - * valid for PP-R ALU also

6.4. Thermal Expansion

6.4.1 Thermal expansion calculation

During the design and installation of plastic pipes, it is very important to calculate the duct expansion caused by a possible difference between operating temperature and starting temperature.

The medium thermal expansion coefficient

It gives the elongation of a bar of 1 meter of pipe for the temperature increasing of 1K.

Medium thermal expansion coefficient

PP-R pipe

$$\alpha = 0,15 \text{ mm/mK}$$

PP-R ALU pipe

$$\alpha = 0,03 \text{ mm/mK}$$

Example

The length variation is calculated with the following formula

$$\Delta L \text{ (mm)} = L \text{ (m)} \times \Delta T \text{ (}^\circ\text{C)} \times \alpha \text{ (mm/m}^\circ\text{C)}$$

L = Initial pipe length (m)
 ΔL = length variation (mm)
 ΔT = temperature difference ($^\circ\text{C}$)
 α = expansion coefficient (mm/m $^\circ\text{C}$)

Length variation

for PP-R pipe

$$\begin{aligned} L &= 5 \text{ m} \\ \Delta L &= 50^\circ\text{K} \\ \alpha &= 0,15 \text{ mm/mK} \end{aligned}$$

$$\Delta L = 5 \times 50 \times 0,15 \quad \Delta L = 37,5 \text{ mm}$$

Length variation

for PP-R - ALU pipe

$$\begin{aligned} L &= 5 \text{ m} \\ \Delta L &= 50^\circ\text{K} \\ \alpha &= 0,03 \text{ mm/mK} \end{aligned}$$

$$\Delta L = 5 \times 50 \times 0,03 \quad \Delta L = 7,5 \text{ mm}$$

Graphical example at page 18

$$L_{BF} = C \times \sqrt{\Delta L \times d_e}$$

L_{BF} = flexible arms length
 C = 20 coeff. PP-R +GF+
 ΔL = length variation (mm)
 d_e = external pipe diameter

Assessment of the flexible arm for PP-R pipe

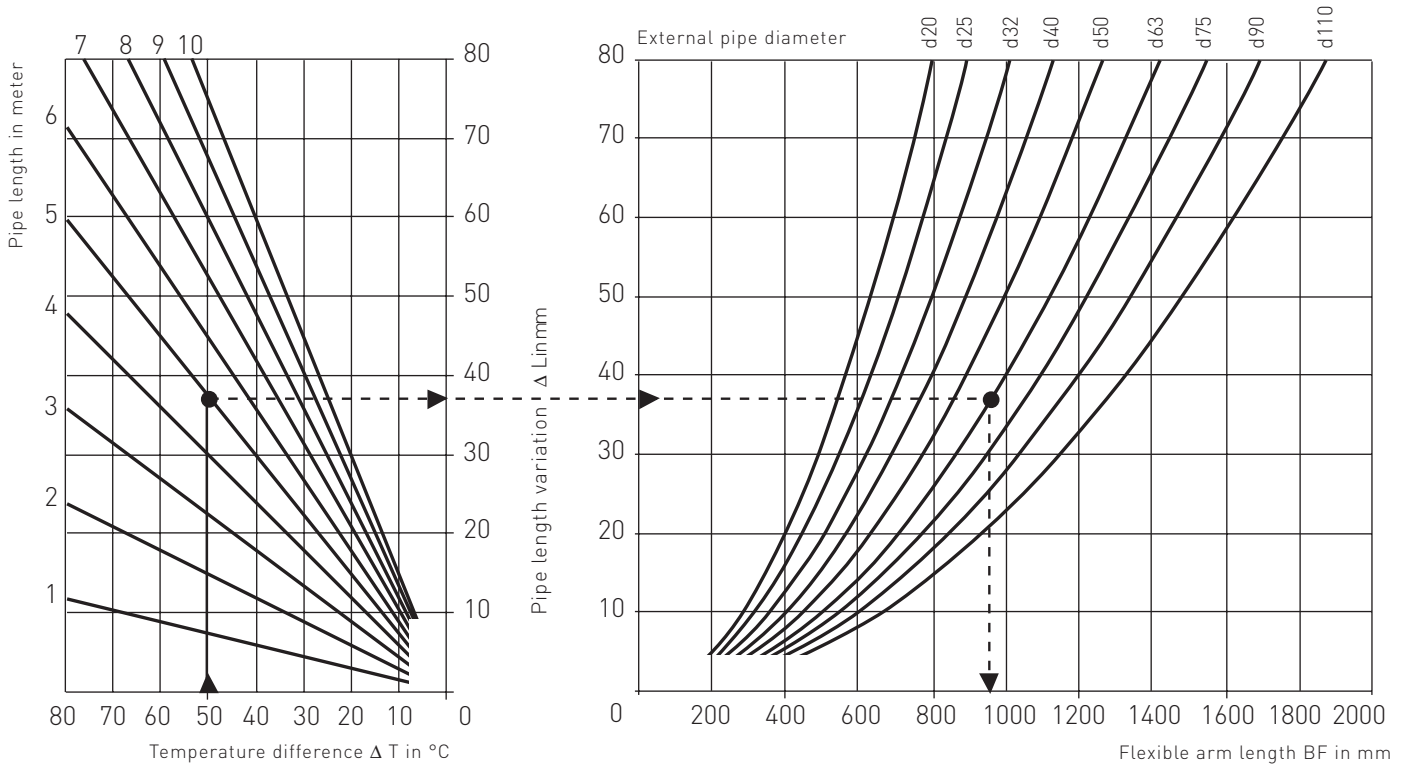

Assessment of the flexible arm for PP-R ALU pipe

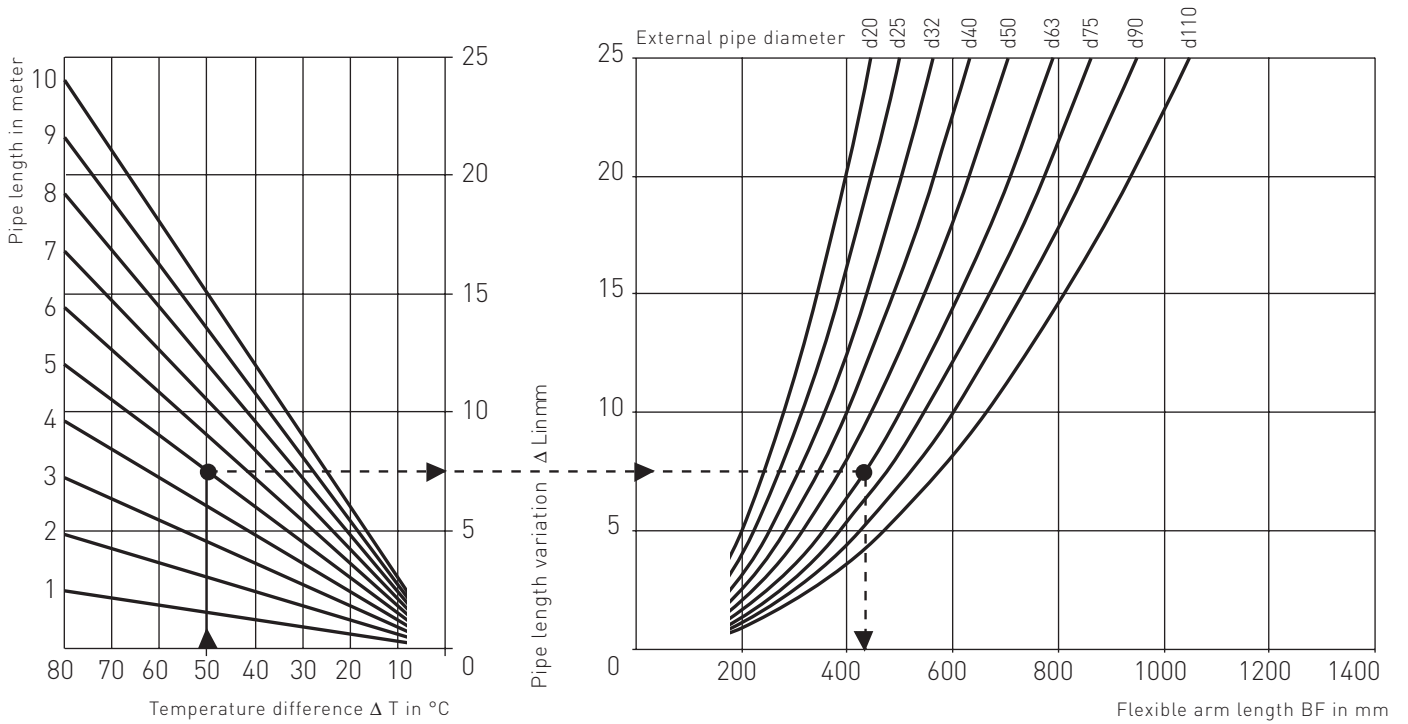

6.4.2. Positioning of the flexible arms

Important: If the operating temperature is higher than the starting temperature, the pipe is lengthened. In the reverse case, the pipe is shortened.

The length difference must also be limited by fixed and movable points suitably placed. The example shown here help to understand how to place fix and movable points.

I° Example

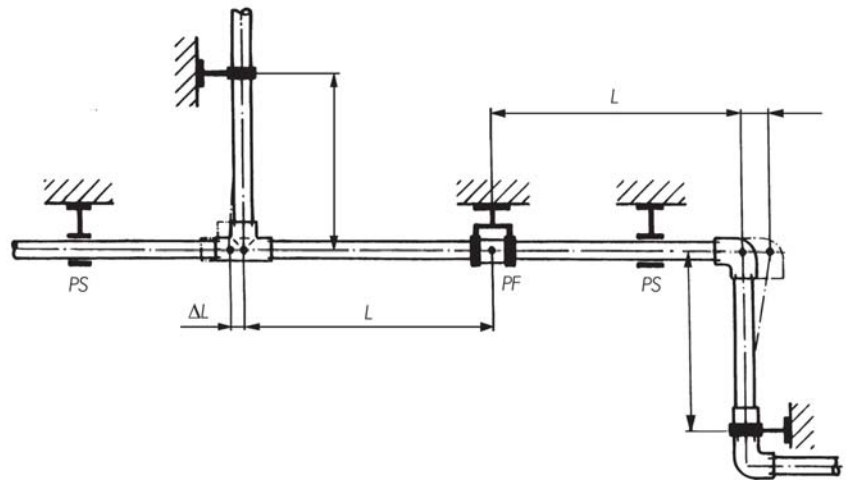

When it is not possible to obtain the length of inflection by changing the direction, use the method illustrated on the right.

II° Example

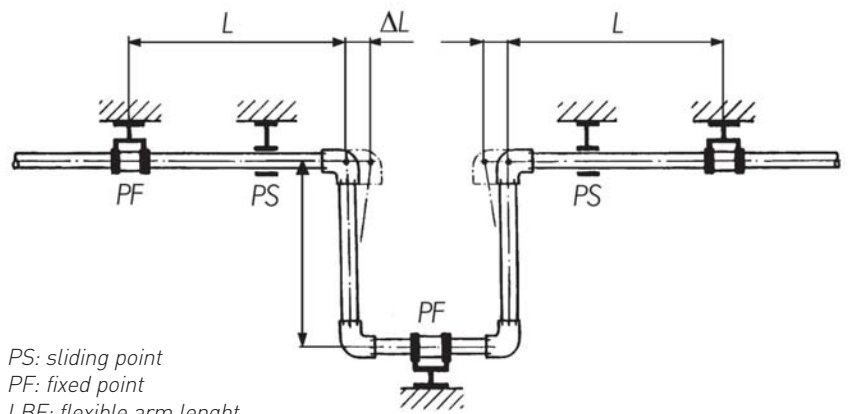

Example for the assessment of the flexible arm

Data: $L = 10 \text{ m}$
 $d = 50 \text{ mm}$
 $T_{\text{installation}} = 15 \text{ }^\circ\text{C}$
 $T_{\text{max operation}} = 80 \text{ }^\circ\text{C}$
 $\Delta L = 0,15 \cdot 10 \cdot 65 = 97,5 \text{ mm}$

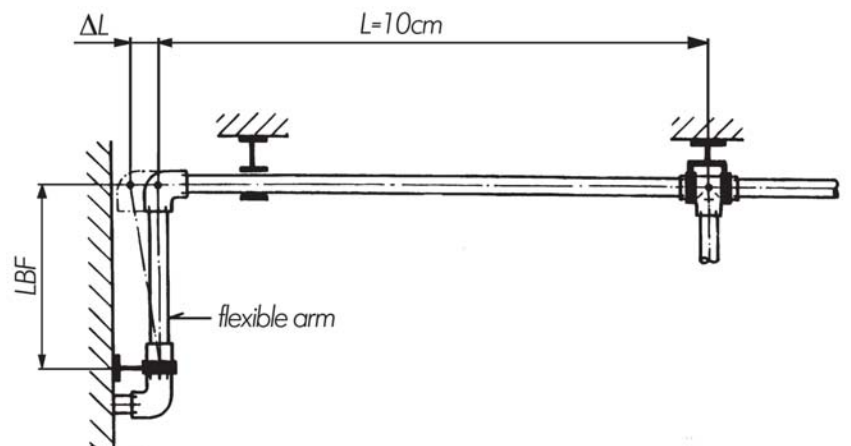

6.4.3 Installation layout

a It is preferable to use pre-insulated pipes, since they allow stretching due to thermal variation and they comply with the Italian regulations. The Act 373 and relevant additions provides for the insulation of hot water pipes, independently of their coefficient of thermal transmittance. In this case, it is important to keep to the following procedure:

- calculate the exact length of the flexible arm (para. 5.4.2)
- use a compressible material (rock-wool, etc), in association with the flexible arms, in order to permit thermal expansion.

b The PP-R pipes can also be embedded directly in concrete, since it can withstand additional axial

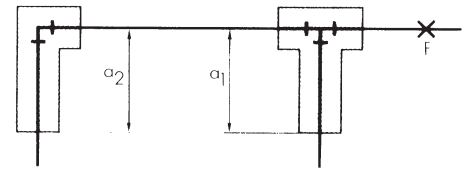

strains, due to thermal expansion being impeded.

In such cases, the stress present on the pipe and fittings must be calculated so as to prevent too high an internal tension and consequent breakages.

It is important to prevent hollows from forming when the pipe is covered with mortar, such hollows could give rise to weak points in the piping. The same consideration applies to pipes positioned between two fixed points.

6.4.5 Pipes brackets

Plastic material pipes need regularly space supports, the bracket distance depends upon many factors such as temperature, pressure, diameter and material.

In every case, the inner diameter of the support must be greater than the external diameter of the pipe, so as to permit pipe movement due to pipe expansion.



For reference, use the table below. Horizontal pipes can be supported by channels or profiles, this can be a more economic solution.

PP-R Pipe bracket table

Material and PN	d mm	distance between two brackets in cm					
		20°C	30°C	40°C	50°C	60°C	70°C
PP-R PN20/10	20	75	75	70	65	60	50
	25	85	85	85	80	75	65
	32	100	100	95	90	85	80
	40	110	110	105	100	95	90
	50	130	125	115	110	105	100
	63	150	145	140	125	120	110
	75	170	165	160	150	145	120
	90	180	175	170	165	160	130
	110	190	185	175	170	165	140
125	195	190	180	175	170	145	

PP-R Pipe bracket table

Material and PN	d mm	distance between two brackets in cm					
		20°C	30°C	40°C	50°C	60°C	70°C
PP-ALU	20	125	125	115	115	105	95
	25	135	130	120	125	115	105
	32	155	150	145	140	130	120
	40	175	170	165	160	150	140
	50	195	190	185	180	170	160
	63	215	210	205	200	190	180
	75	225	220	215	210	200	190
	90	235	230	225	220	210	200
	110	250	240	230	210	200	200

7. Instructions for correct socket fusion

7.1 Preparation

All the following descriptions are valid for both PP-R and PP-R ALU pipe. The only exception at paragraph 7.1.5 where you need two different tools.

7.1.1 Check the temperature

Once the socket fusion machine is on, check the temperature, which must range between 253°C and 274°C.

This operation must be performed by means of tempil sticks.

The yellow one melts at 253°C.

The red one melts at 274°C.

The fusion temperature ranges between 253°C and 273°C, when the yellow pen melts and the red one does not melt, the temperature is perfect for fusion.



N.B. Cut the pipe ends of 5 cm.



7.1.2 Clean the heating tools

After checking the heater bush temperature, wipe the heater bush with a clean cloth. This operation must be repeated after each welding.



7.1.4 Chamfer the PP-R/ALU/PP-R

In case of PP-R ALU pipe to take off the aluminium film use the suitable tools.

7.1.5 Clean pipe & fitting

Clean the fitting inside and the pipe outside (the presence of dust can cause improper fusion).



7.1.3 Cut the pipe

Cut the pipe at right angle, if necessary remove swarf from inside.



7.2 Fusion

7.2.1 Mark the pipe

Mark the pipe for depth of penetration into the heater bush and fitting (see table). The mark must remain visible under heating and joining.



7.2.2 Heat pipe & fitting

Push the pipe and the fitting into the heating tools. Once pipe and fitting are hot (after the correct time), pull out pipe and fitting very slowly.



7.2.3 Joint pipe & fitting

Joint the pipe & the fitting and push the pipe until it reaches the mark (that has to stay outside).

During the jointing time the welded part of pipe and fitting must remain fix, without any rotation.

During the cooling time, the welded part of pipe and fitting can be adjusted until cold.



7.2.4 Fusion inspection

Fusion inspection.

The outer fusion seam must be inspected. The seam must be present all around the pipe.



Summary Value table

pipe diameter (mm)	minimum wall thickness (mm)	insert depth (mm)	heating time (sec.)	jointing time (sec.)	cooling time (min.)
20	3,4	14	6	4	2
25	4,2	16	7	4	3
32	5,4	18	8	6	4
40	6,7	20	12	6	4
50	8,4	23	18	6	5
63	10,5	26	25	8	6
75	12,5	28	30	8	8
90	15,0	31	40	10	8
110	18,4	33	50	10	8
125	20,8	40	60	10	8

8. Electrofusion

The welding can also be made by means of the electrofusion machine. This machine is useful in the repair situation, where it is difficult to use the standard machine and where there is a little space.

Pay attention to the following instructions:

1. Wipe the coupling area of the pipe with a clean cloth. Scrap the same area with a blade all around the pipe. Check the pipe ovalisation (<1.5%).



2. Just before electrofusion, degrease the treated pipe end by means of solvent and lint free cloth.

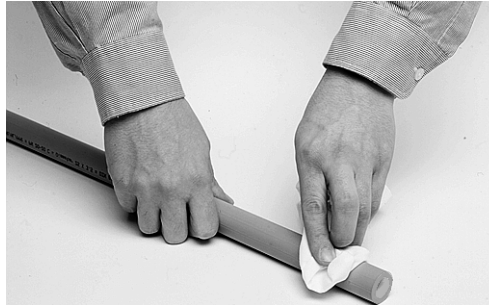

3. Unpack the fitting and position it on the pipe, so that the sleeve-end matches the pipe-end. Insert the end of the other pipe. Make sure that both ends of the pipe are lined up and secure the fitting and the pipe.



4. Fix the electrofusion machines cables so that the cables do not weigh on the clamps. Connect the clamps to the resistor terminals on the fitting and make sure that the connection is correct. Follow the instructions to program and operate the welding machine.



Minimum cooling time without moving sleeve and pipe

d mm	minutes
20	10
25	10
32	10
40	15
50	15
63	20
75	25
90	30
110	35
125	40

about 2 hours hardening time must be allowed from when the fitting is cool before any pressure tests can be used.

9. Hole repairing

In case of accidental drilling it is possible to repair the pipe as follows:

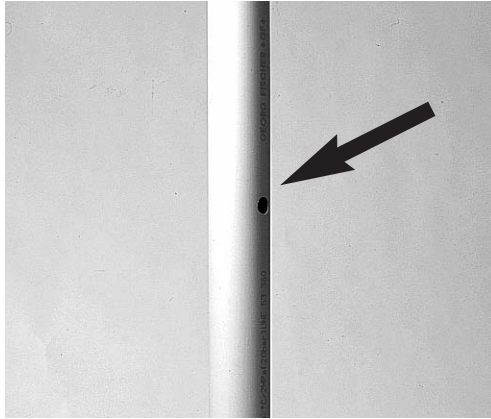

1. As first, adequate the hole to the hole member dimension. They are available in 7 mm and 11 mm, respectively repairing an hole of 6 mm and 10 mm. Take the hole to this dimensions.

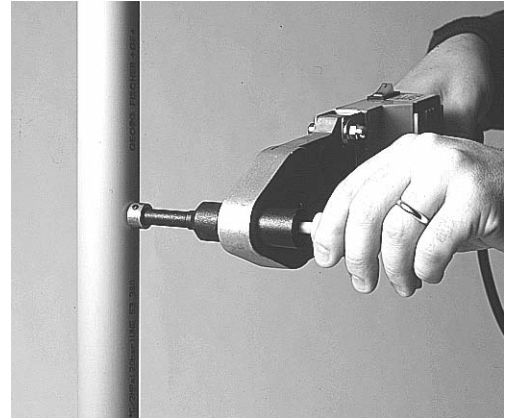

2. Proceed to the normal fusion, heating the two part for 5 sec. positioning in relation to the thickness of the pipe, the ogive in brass. This avoid to waste the pipe.



3. Joint the two parts and keep the repairing part for a while until cool.



4. Wait after the cooling time before cutting the part in excess.

10. PPR saddles installation

Assemble the special heating tools for saddles with a standard socket welder. Once the socket welder is on, check the temperature, which must be in the range of 253-274°C (this operation may be performed by means of thermostatic sticks). Wipe the heating tools with a clean cloth. Clean the surfaces to be welded by means of light specific solvent (TANGIT KS).



Scrap the pipe surface with a blade. With PPR-ALU pipes, the aluminium layer must be removed.



Drill the pipe with the specific drill, taking into consideration the saddle spigot diameter. The chip will be taken out, avoiding any pipe contamination. It is possible to smooth the hole mouth changing the turning drill direction.



Push the saddle heating tool with the spigot into the pipe hole and the saddle into the other tool. Heat the pipe surface and the saddle for 30".



Once the heating process is over, remove the socket welder and push the saddles spigot into the pipe hole with a light pressure until the surfaces will meet entirely. Keep the position for 15-20 seconds and let the system cool down for 30 min, before making the pressure test.

Table 1. Welding parameter

Diameter Pipe (mm)	Diameter derivation (mm)	Heating time pipe (sec)	Heating time saddle (sec)	holding time (sec)	Cooling time (min)
40	20	30	30	20	30
40	25	30	30	20	30
50	20	30	30	20	30
50	25	30	30	20	30
63	20	30	30	20	30
63	25	30	30	20	30
63	32	30	30	20	30
75	20	30	30	20	30
75	25	30	30	20	30
75	32	30	30	20	30
75	40	30	30	20	30
90	20	30	30	20	30
90	25	30	30	20	30
90	32	30	30	20	30
90	40	30	30	20	30
110	20	30	30	20	30
110	25	30	30	20	30
110	32	30	30	20	30
110	40	30	30	20	30
125	20	30	30	20	30
125	25	30	30	20	30
125	32	30	30	20	30
125	40	30	30	20	30
40	1/2"	30	30	20	30
40	3/4"	30	30	20	30
50	1/2"	30	30	20	30
50	3/4"	30	30	20	30
63	1/2"	30	30	20	30
63	3/4"	30	30	20	30
75	1/2"	30	30	20	30
75	3/4"	30	30	20	30
75	1"	30	30	20	30
90	1/2"	30	30	20	30
90	3/4"	30	30	20	30
90	1"	30	30	20	30
110	1/2"	30	30	20	30
110	3/4"	30	30	20	30
110	1"	30	30	20	30
125	1/2"	30	30	20	30
125	3/4"	30	30	20	30
125	1"	30	30	20	30

11. System pipes and fittings

4001

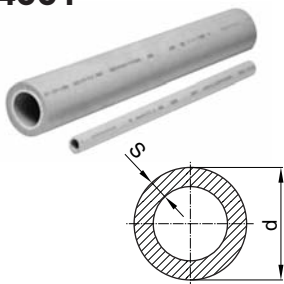

Pipe PN20

d x s	Code	GP	Kg/m	L
20 x3,4	760 840 002	90 mt	0,176	3000
25 x4,2	760 840 003	60 mt	0,270	3000
32 x5,4	760 840 004	45 mt	0,444	3000
40 x6,7	760 840 005	30 mt	0,686	3000
50 x8,4	760 840 006	15 mt	1,037	3000
63x10,5	760 840 007	9 mt	1,688	3000
75x12,5	760 840 008	9 mt	2,409	3000
90x15,0	760 840 009	6 mt	3,450	3000
110x18,4	760 840 010	6 mt	4,910	3000
125x20,8	760 840 011	3 mt	6,490	3000

4002

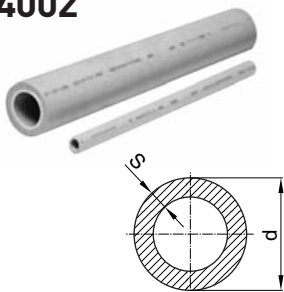

Pipe PN10 for cold water only

d x s	Code	GP	Kg/m	L
20 x1,9	760 840 012	90 mt	0,107	3000
25 x2,3	760 840 013	60 mt	0,164	3000
32 x3,0	760 840 014	45 mt	0,267	3000
40 x3,7	790 840 015	30 mt	0,412	3000
50 x4,6	760 840 016	15 mt	0,636	3000
63 x5,8	760 840 017	9 mt	1,005	3000
75 x6,9	760 840 018	9 mt	1,418	3000
90 x8,2	760 840 019	6 mt	2,03	3000
110x10,0	760 840 020	6 mt	3,01	3000
125x11,4	760 840 021	3 mt	5,58	3000

4301

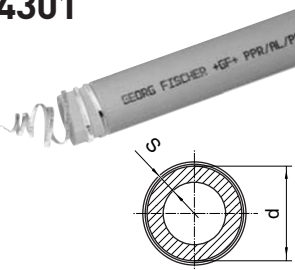

PP-R ALU pipe with aluminium

d x s	Code	GP	Kg/m	L
20 x2,8	760 840 902	100 mt	0,192	4000
25 x3,5	760 840 903	100 mt	0,298	4000
32 x4,4	760 840 904	40 mt	0,460	4000
40 x5,5	760 840 905	40 mt	0,680	4000
50 x6,9	760 840 906	20 mt	1,055	4000
63 x8,7	760 840 907	20 mt	1,585	4000
75x10,3	760 840 908	12 mt	2,205	4000
90x12,3	760 840 909	8 mt	3,235	4000
110x15,1	760 840 910	4 mt	4,880	4000

4003

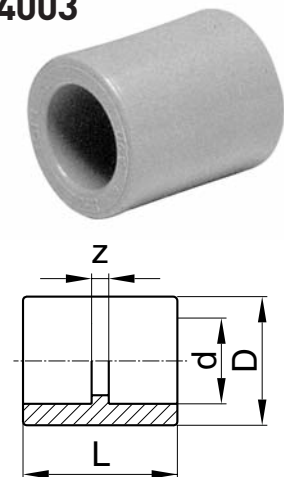

Socket

d	Code	SP	GP	g	D	L	z
20	760 840 022	20	180	13	30	36	4
25	760 840 023	15	135	17	34	40	4
32	760 840 024	10	70	26	42	43	3
40	760 840 025	10	40	52	55	47	3
50	760 840 026	6	24	91	69	53	3
63	760 840 027	2	10	167	86	62	4
75	760 840 028	2	8	168	107	67	5
90	760 840 029	1	6	280	127	74	6
110	760 840 030	1	1	379	148	80	6
125	760 840 031	1	1	758	165	90	10

4005

90° elbow

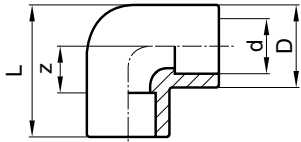

d	Code	SP	GP	g	D	L	z
20	760 840 032	20	140	18	30	42	11
25	760 840 033	10	80	30	34	48	13
32	760 840 034	10	50	46	42	59	18
40	760 840 035	5	25	90	55	71	21
50	760 840 036	4	12	168	69	87	27
63	760 840 037	2	8	315	86	106	34
75	760 840 038	1	4	535	107	124	39
90	760 840 039	1	2	861	129	145	45
110	760 840 040	1	1	1093	148	173	62
125	760 840 041	1	1	2311	165	206	84

4007

90° elbow, male-female

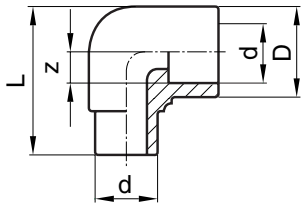

d	Code	SP	GP	g	D	L	z
20	760 840 042	20	140	18	29	45	14
25	760 840 047	10	80	29	34	51	16
32	760 840 048	10	50	48	42	60	19

4009

45° elbow

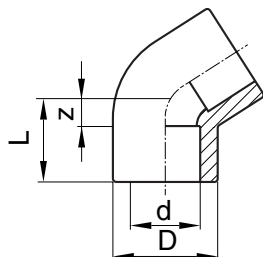

d	Code	SP	GP	g	D	L	z
20	760 840 052	20	160	15	30	20	5
25	760 840 053	20	100	20	34	22	6
32	760 840 054	10	60	31	42	27	8
40	760 840 055	10	30	69	55	31	10
50	760 840 056	5	15	124	69	36	12
63	760 840 057	2	8	237	86	44	14
75	760 840 058	1	4	396	107	47,5	16
90	760 840 059	1	2	531	122	55	19
110	760 840 060	1	1	650	148	69	32
125	760 840 061	1	1	1522	165	77	37

4025

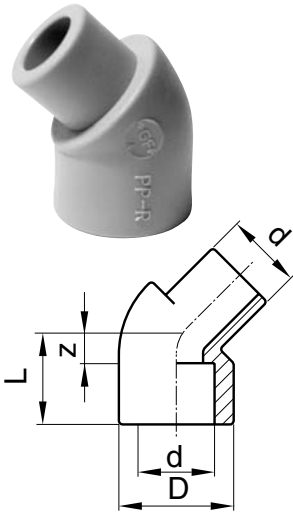

45° elbow, male-female

d	Code	SP	GP	g	D	L	z
20	760 840 172	20	100	15	30	20	5

4011

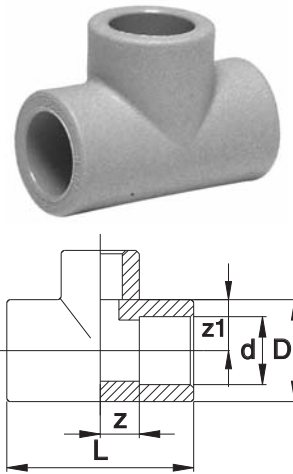

90° tee

d	Code	SP	GP	g	D	L	z	z1
20	760 840 062	20	100	23	30	55	11,5	11,5
25	760 840 063	10	60	36	34	64	14	14
32	760 840 064	10	30	69	42	77	18,5	18,5
40	760 840 065	5	15	126	55	87	21,5	21,5
50	760 840 066	2	10	239	69	105	27,5	27,5
63	760 840 067	1	4	444	86	126	34	34
75	760 840 068	1	4	704	107	141	39,5	39,5
90	760 840 069	1	2	921	123	162	46	46
110	760 840 070	1	1	1277	148	198	62	62
125	760 840 080	1	1	2820	165	248	84	84

4013

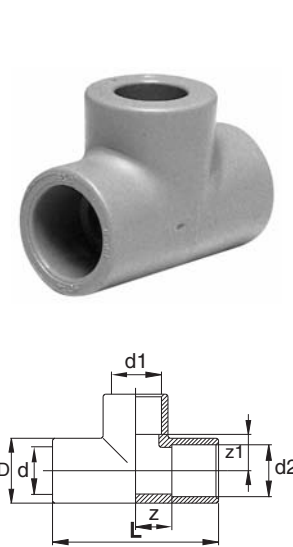

Reducing tee

d - d1 - d2	Code	SP	GP	g	D	L	z	z1
25- 20- 25	760 840 071	10	60	38	34	64	14	14
25- 20- 20	760 840 072	10	60	41	34	64	15	14
25- 25- 20	760 840 073	10	60	38	34	64	15	14
32- 20- 32	760 840 076	10	30	64	42	77	18,5	18,5
32- 25- 32	760 840 077	10	30	64	42	77	18,5	18,5
32- 32- 25	760 840 078	10	30	64	42	77	19,5	18,5
32- 25- 25	760 840 079	10	30	68	42	77	19,5	18,5
40- 20- 40	760 840 082	5	15	138	52	88	24	24
40- 25- 40	760 840 083	5	15	136	52	88	24	24
40- 32- 40	760 840 084	5	15	135	55	88	24,7	25,5
50- 20- 50	760 840 087	2	10	268	65	104	28	31
50- 25- 50	760 840 088	2	10	264	65	104	28	30
50- 32- 50	760 840 089	2	10	260	65	104	28	28
50- 40- 50	760 840 090	2	10	254	69	106	27	32
63- 25- 63	760 840 092	1	4	490	85	124	35	46
63- 32- 63	760 840 093	1	4	485	85	124	35	44
63- 40- 63	760 840 094	1	4	480	85	124	35	35
63- 50- 63	760 840 095	1	4	473	86	128	34	34
75- 25- 75	760 840 086	1	4	690	100	142	41	55
75- 32- 75	760 840 096	1	4	680	100	142	41	53
75- 40- 75	760 840 097	1	4	670	100	142	41	51
75- 50- 75	760 840 098	1	4	660	100	142	41	48
75- 63- 75	760 840 099	1	4	650	107	141	39,5	35
90- 75- 90	760 840 100	1	2	881	120	166	50	53
110- 90- 110	760 840 101	1	2	1280	165	248	84	84

4015

Reducing bush, male-female

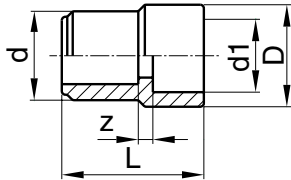

d - d1	Code	SP	GP	g	D	L	z
25 - 20	760 840 102	20	200	10	28	39	5
32 - 20	760 840 105	15	120	16	28	44	8
32 - 25	760 840 106	15	120	18	33	46	8
40 - 20	760 840 107	10	80	27	29	47	10
40 - 25	760 840 109	10	80	29	35	50	11
40 - 32	760 840 110	10	80	34	44	52	11
50 - 20	760 840 111	10	40	47	27	53	12
50 - 25	760 840 112	10	40	52	34	55	12
50 - 32	760 840 114	10	40	52	44	58	13
50 - 40	760 840 115	10	40	61	55	60	13
63 - 20	760 840 117	5	20	87	27	60	15
63 - 25	760 840 118	5	20	86	32	62	15
63 - 32	760 840 119	5	20	86	42	64	15
63 - 40	760 840 120	5	20	97	55	70	19
63 - 50	760 840 121	5	20	111	59	70	17
75 - 25	760 840 129	2	10	127	32	66	12
75 - 32	760 840 130	2	10	129	42	63	12
75 - 40	760 840 122	2	10	135	55	63	14
75 - 50	760 840 123	2	10	150	70	70	14
75 - 63	760 840 124	2	10	183	87	75	15
90 - 50	760 840 125	2	8	192	71	72	17
90 - 63	760 840 126	2	8	205	86	82	19
90 - 75	760 840 127	2	8	245	100	84	19
110 - 63	760 840 139	1	1	300	130	87	27
110 - 75	760 840 116	1	1	360	130	90	29
110 - 90	760 840 128	1	1	344	130	93	31
125 - 110	760 840 131	1	1	1245	130	45	35

4017

Cap

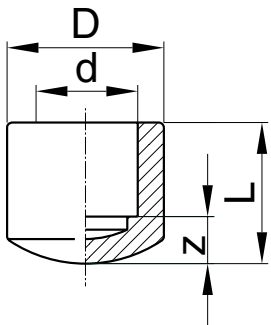
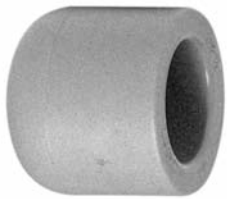

d	Code	SP	GP	g	D	L	z
20	760 840 132	20	240	10	30	27	11
25	760 840 133	20	200	13	34	29	11
32	760 840 134	10	100	21	42	33	13
40	760 840 135	10	60	39	55	35	15
50	760 840 136	10	30	73	69	42	20
63	760 840 137	5	20	137	86	50	25
75	760 840 138	2	8	251	107	58	27

4019

Swan neck

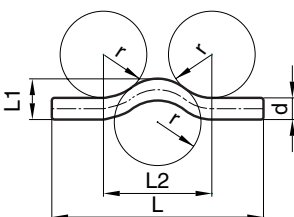

d	Code	SP	GP	g	r	L	L1	L2
20	760 840 142	10	80	64	80	350	45	200
25	760 840 143	10	60	99	80	350	55	200
32	760 840 144	8	32	156	80	350	67	200

4020

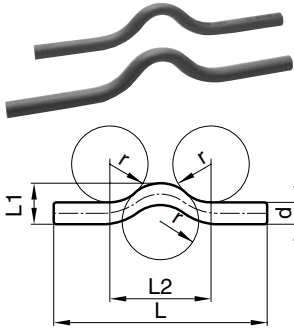

Narrow swan neck

d	Code	SP	GP	g	r	L	L1	L2
20	760 840 146	10	80	64	70	365	55	180

4022



Narrow swan neck F-F

d	Code	SP	GP	l	h
20	760 840 148	10	50	160	48
25	760 840 149	10	30	200	60

4021

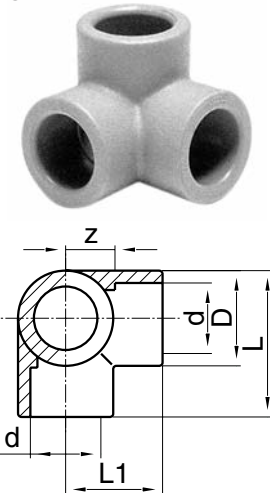

Three-ways welding 90° elbow

d	Code	SP	GP	g	D	L	L1	z
20	760 840 152	20	100	22	30	41,5	27,5	10

4023

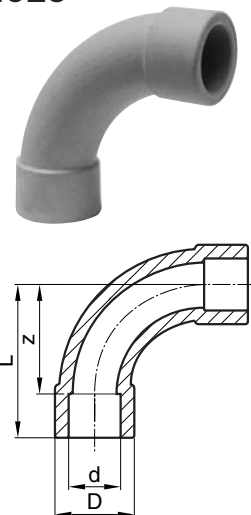

90° bend

d	Code	SP	GP	g	D	L	z
20	760 840 162	10	100	31	29	70	40
25	760 840 163	10	50	38	34	85	50

4026

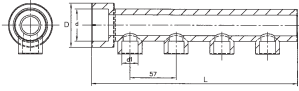

Manifold

d	Code	SP	GP	g	D	L	z
40 x 20	760 840 182	1	10	203	55	255	57
40 x 1/2"	760 840 186	1	10	461	55	255	57

4027

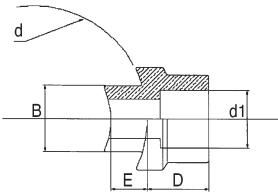

Saddle with spigot

d - d1	Code	SP	GP	B	D	E
40-20	760 840 190F	10	10	22	20	6,5
40-25	760 840 191F	10	10	22	27	6,5
50-20	760 840 192F	10	10	22	20	8
50-25	760 840 193F	10	10	22	27	8
63-20	760 840 194F	10	10	22	20	10
63-25	760 840 195F	10	10	22	27	10
63-32	760 840 196F	10	10	32	30	10
75-20	760 840 197F	10	10	22	20	10
75-25	760 840 198F	10	10	22	27	10
75-32	760 840 199F	10	10	32	30	10
75-40	760 840 200F	10	10	32	30	15
90-20	760 840 220F	10	10	22	20	15
90-25	760 840 221F	10	10	22	27	15
90-32	760 840 222F	10	10	32	30	15
90-40	760 840 231F	10	10	32	30	15
110-20	760 840 223F	10	10	22	20	15
110-25	760 840 224F	10	10	22	27	15
110-32	760 840 225F	10	10	32	30	15
110-40	760 840 226F	10	10	32	30	15
125-20	760 840 227F	10	10	22	27	15
125-25	760 840 228F	10	10	22	30	15
125-32	760 840 229F	10	10	32	30	15
125-40	760 840 230F	10	10	32	30	15

4092

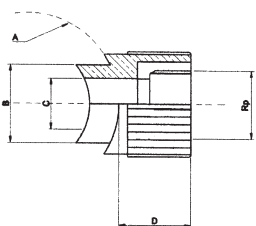

Threaded female saddles with spigot

d - Rp	Code	SP	GP	B	C	D
40 - 1/2"	760 840 764F	10	10	22	13	27
50 - 1/2"	760 840 766F	10	10	22	13	27
50 - 3/4"	760 840 767F	10	10	32	21	30
63 - 1/2"	760 840 768F	10	10	22	13	27
63 - 3/4"	760 840 769F	10	10	32	21	30
75 - 1/2"	760 840 770F	10	10	22	13	27
75 - 3/4"	760 840 771F	10	10	32	21	30
75 - 1"	760 840 772F	10	10	32	22	34
90 - 1/2"	760 840 773F	10	10	22	13	27
90 - 3/4"	760 840 774F	10	10	32	21	30
90 - 1"	760 840 775F	10	10	32	22	34
110 - 1/2"	760 840 776F	10	10	22	13	27
110 - 3/4"	760 840 777F	10	10	32	21	30
110 - 1"	760 840 778F	10	10	32	22	34
125 - 1/2"	760 840 779F	10	10	22	14	27
125 - 3/4"	760 840 780F	10	10	32	22	30
125 - 1"	760 840 781F	10	10	32	22	34

4029

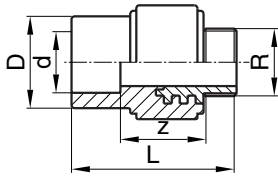

Threaded male coupling

d - R	Code	SP	GP	g	D	L	z
20 - 1/2"	760 840 241	10	90	86	30	54	23
20 - 3/4"	760 840 242	10	60	137	34	56	24
25 - 1/2"	760 840 243	10	60	88	34	56	25
25 - 3/4"	760 840 244	10	60	134	34	56	22
32 - 3/4"	760 840 245	6	30	137	42	67	31
32 - 1"	760 840 246	6	30	328	42	80	43
40 - 1"	760 840 239	6	12	338	54	86	28
40 - 1 1/4"	760 840 247	2	12	463	54	85	43
50 - 1 1/2"	760 840 248	2	12	529	68	89	44
63 - 2"	760 840 249	2	8	776	85	100	46
75 - 2 1/2"	760 840 250	1	5	1170	101	108	50
90 - 3"	760 840 238	1	1	1450	121	113	50

4030

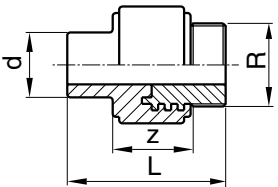

Threaded male coupling for connection

d - R	Code	SP	GP	g	L	z
20 - 1/2"	760 840 251	10	90	83	52	21
25 - 1/2"	760 840 253	10	70	88	52	21
25 - 3/4"	760 840 254	10	70	131	55	21
32 - 3/4"	760 840 255	6	30	168	65	29
32 - 1"	760 840 256	6	30	323	77	40
40 - 1"	760 840 257	6	12	324	78	33

4031

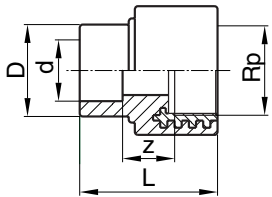

Threaded female coupling

d - Rp	Code	SP	GP	g	D	L	z
20 - 1/2"	760 840 271	10	100	76	30	42	13
20 - 3/4"	760 840 272	10	70	84	34	42	12
25 - 1/2"	760 840 273	10	70	78	34	42	11
25 - 3/4"	760 840 274	10	70	83	34	42	10
32 - 3/4"	760 840 275	6	30	89	42	53	19
32 - 1"	760 840 276	6	30	240	42	62	25
40 - 1"	760 840 269	6	12	249	54	71	28
40 - 1 1/4"	760 840 277	2	12	381	54	68	26
50 - 1 1/2"	760 840 278	2	12	441	68	71	26
63 - 2"	760 840 279	2	8	610	85	80	26
75 - 2 1/2"	760 840 280	1	5	803	101	83	25

4032

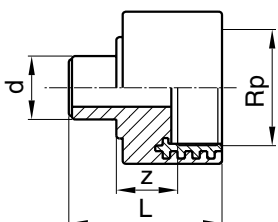

Threaded female coupling for connection

d - Rp	Code	SP	GP	g	L	z
20 - 1/2"	760 840 281	10	100	66	40	13
25 - 1/2"	760 840 283	10	80	75	40	11
25 - 3/4"	760 840 284	10	80	79	40	10
32 - 3/4"	760 840 285	6	30	117	51	19
32 - 1"	760 840 286	6	30	233	61	26
40 - 1"	760 840 287	6	12	235	62	24

4033

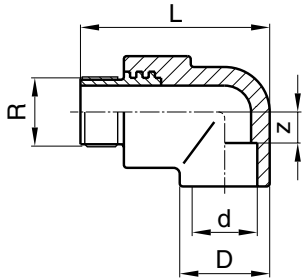

Threaded male 90° elbow

d - R	Code	SP	GP	g	D	L	z
20 - 1/2"	760 840 291	10	70	94	29	61	12
20 - 3/4"	760 840 292	10	50	141	29	65	12
25 - 1/2"	760 840 293	10	40	109	34	69	15
25 - 3/4"	760 840 294	10	40	153	34	71	15
32 - 3/4"	760 840 295	6	30	163	42	83	17
32 - 1"	760 840 296	6	24	345	43	91	19

4035

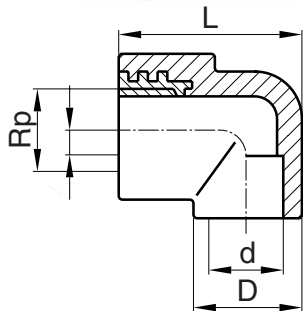

Threaded female 90° elbow

d - Rp	Code	SP	GP	g	D	L	z
20 - 1/2"	760 840 301	10	80	85	29	49	12
20 - 3/4"	760 840 302	10	50	91	29	49	12
25 - 1/2"	760 840 303	10	70	98	34	57	15
25 - 3/4"	760 840 304	10	40	103	34	57	15
32 - 3/4"	760 840 305	5	40	113	43	69	17
32 - 1"	760 840 306	6	24	256	44	75	19

4036

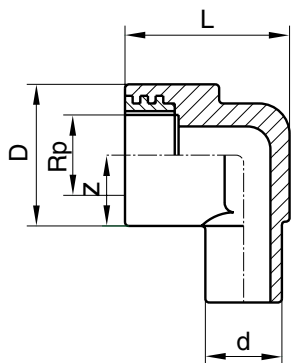

Threaded female 90° elbow with spigot

d - Rp	Code	SP	GP	g	D	L	z
20 - 1/2"	760 840 315	10	80	79	37	43	14

4037

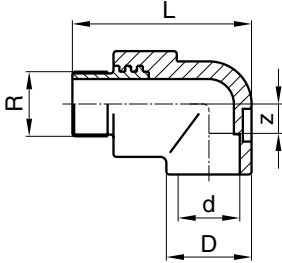

Threaded male 90° elbow with bracket

d - R	Code	SP	GP	g	D	L	z
20 - 1/2	760 840 321	10	60	96	29	62	12

4039

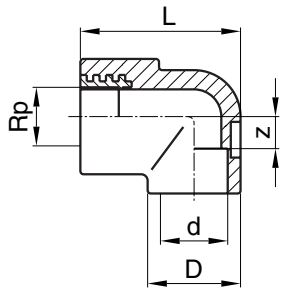

Threaded female 90° elbow with bracket

d - Rp	Code	SP	GP	g	D	L	z
20 - 1/2	760 840 331	10	70	88	29	50	12

4040

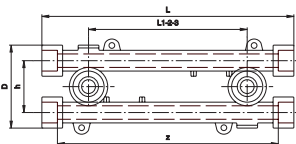
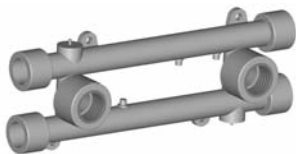

Modular fastening

d - Rp	Code	SP	GP	g	L	D	z	L1	L2	L3
20 - 1/2	760 840 335	1	8	129	248	80	220	100	135	153

Variable Wheelbare 130-150-180 mm

4040

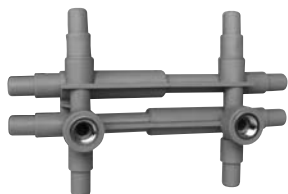

Distribution element

d - Rp	Code	SP	GP	g
20 - 25 1/2"	760 840 336	1	6	422
20 - 25 3/4"	760 840 337	1	6	462

4041

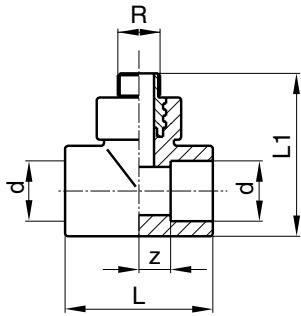

Threaded male tee

d - R	Code	SP	GP	g	L1	L	z
20 - 1/2	760 840 341	10	60	98	64	55	11
20 - 3/4	760 840 342	10	50	144	65	55	11
25 - 1/2	760 840 343	10	40	111	69	64	14
25 - 3/4	760 840 344	10	40	160	72	64	14
32 - 3/4	760 840 345	6	24	184	79	77	18
32 - 1	760 840 346	6	18	357	91	77	18

4043

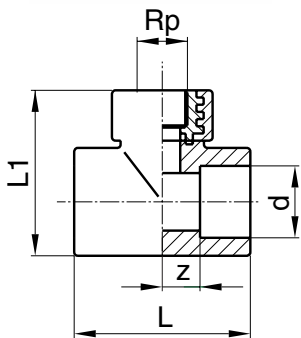

Threaded female tee

d - Rp	Code	SP	GP	g	L1	L	z
20 - 1/2	760 840 351	10	70	87	50	55	11
20 - 3/4	760 840 352	10	50	95	50	55	11
25 - 1/2	760 840 353	10	40	103	57	64	14
25 - 3/4	760 840 354	10	40	108	57	64	14
32 - 1/2	760 840 360	6	24	126	64	77	18
32 - 3/4	760 840 355	6	24	133	64	77	18
32 - 1	760 840 356	6	18	267	75	77	18

4045

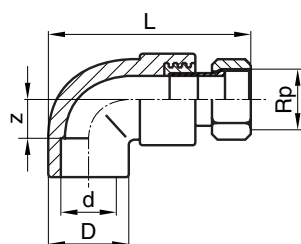

90° elbow for metal taper threaded

d - Rp	Code	SP	GP	g	D	L	z
20 - 3/4	760 840 362	10	70	145	29	69	12
25 - 1	760 840 365	10	40	209	34	91	15
25 - 1 1/4	760 840 367	6	24	414	43	101	19

4047

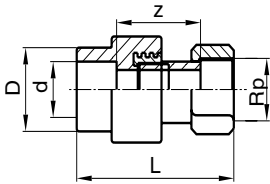

Adaptor union for metal taper threaded

d - Rp	Code	SP	GP	g	D	L	z
20 - 3/4	760 840 372	10	60	130	30	63	23
25 - 1	760 840 375	10	40	189	34	68	27
32 - 1 1/4	760 840 377	6	18	315	43	90	30
40 - 1 1/2	760 840 379	1	10	620	54	102	68
50 - 2	760 840 380	1	10	807	68	110	72

4048

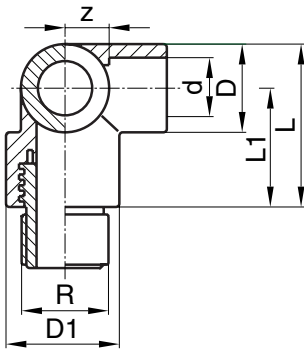

Three-ways wending threaded male 90° elbow

d - R	Code	SP	GP	g	D	L	z	L1	D1
20 - 1/2	760 840 382	10	70	97	29	62,5	12	35	37

4049

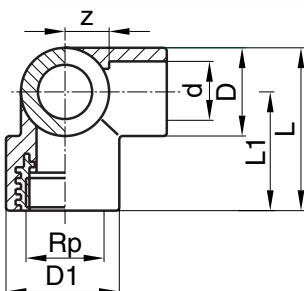

Three-ways wending threaded female 90° elbow

d - Rp	Code	SP	GP	g	D	L	z	L1	D1
20 - 1/2	760 840 392	10	80	87	29	49,5	12	35	37

4086

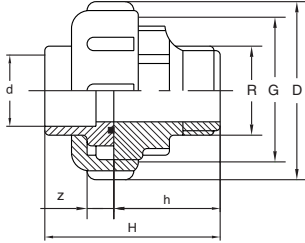

Adaptor union socket threaded male

d - Rp	Code		SP	GP	g	H	h	z	G	D
25 - 3/4	760 840 702		10	20	300	67	41	8	1 1/2	56
32 - 1	760 840 703		5	10	430	73	45	8	2 1/2	69
40 - 1 1/4	760 840 704		5	10	640	80	48	10	2 1/2	83
50 - 1 1/2	760 840 705		2	5	730	83	48	10	2 3/4	90
63 - 2	760 840 706		2	4	1050	92	54	10	3 1/2	104

4088

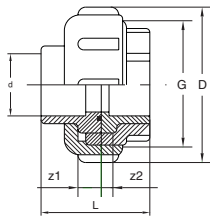

Adaptor union socket-socket

d	Code		SP	GP	g	L	z1	z2	G	D
25	760 840 732		10	20	210	49	8	5	1 1/2	56
32	760 840 733		5	10	290	53	8	5	2 1/2	69
40	760 840 734		5	10	460	59	10	5	2 1/2	83
50	760 840 735		2	5	490	65	10	5	2 3/4	90
63	760 840 736		2	4	710	71	10	5	3 1/2	110

4053

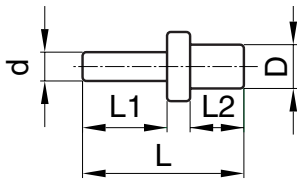

Repairing hole

d	Code		SP	GP	g	D	L		L1	L2
7,5/11,4	760 840 425		20	20	4	11,4	42		22	14

4050

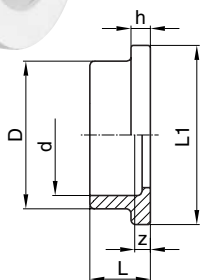

Flange adaptor

d	Code		SP	GP	g	D	L	z	L1
25	760 840 414		10	50	12	33	23	5	41
32	760 840 415		6	30	18	41	25	5	50
40	760 840 416		4	20	24	50	27	5	61
50	760 840 417		2	10	46	61	33	8	74
63	760 840 418		2	10	84	76	37	8	91
75	760 840 419		2	10	140	90	39	8	107
90	760 840 420		2	8	213	106	46	10	126
110	760 840 421		1	1	240	131	49	7	150
125	760 840 422		1	1	363	146	55	15	162

5085

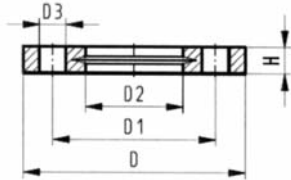

Backing flange

d	DN	PN	Code	SP	GP	D	D1	D2	D3	H	AL
25	20	16	727 700 407	2		105	75	34	14	17	4
32	25	16	727 700 408	2		115	85	42	14	18	4
40	32	16	727 700 409	2		140	100	51	18	20	4
50	40	16	727 700 410	2		150	110	62	18	22	4
63	50	16	727 700 411	2		165	125	78	18	24	4
75	65	16	727 700 412	2		185	145	92	18	26	4
90	80	16	727 700 413	2		200	160	110	18	27	8
110	100	16	727 700 414	2		220	180	133	18	28	8
125	100	16	727 700 215	2		250	210	150	18	24	8

5087

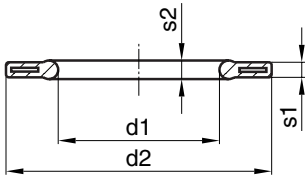

Flange seals EPDM

d	Code	SP	GP	g	d2	d1	s1	s2
25	761 066 330	5		12	61	25	3	4
32	761 066 331	5		15	71	32	3	4
40	761 066 332	5		19	82	40	3	4
50	761 066 333	5		22	92	50	3	4
63	761 066 334	5		41	107	63	4	5
75	761 066 315	1		54	127	75	4	5
90	761 066 316	1		60	142	90	4	5
110	761 066 317	1		83	162	110	5	6

4055



Stop cock with handle

d	Code	SP	GP	g	D	L	z	L1
20	760 840 462	4	16	359	28	77	22	114
25	760 840 463	4	16	384	36	87	25	118
32	760 840 464	4	16	494	43	90	25	119

4055



Stop cock

d	Code	SP	GP	g	D	L	z	L1
20	760 840 432	4	16	309	28	77	22	91
25	760 840 433	4	16	292	36	87	25	91
32	760 840 434	4	16	351	43	90	25	98

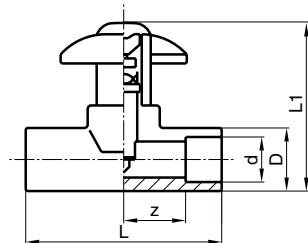

Handle for cock

20/25/32	760 840 436	10	100	64	36	87	16/18	121
----------	-------------	----	-----	----	----	----	-------	-----



Extension for cock

20/25/32	760 840 438	10	100	96	36	87	16/18	130
----------	-------------	----	-----	----	----	----	-------	-----

Covering tube ①

	760 840 430							
--	-------------	--	--	--	--	--	--	--

Covering plate ②

	760 840 431							
--	-------------	--	--	--	--	--	--	--

Stop cock components ③

20/25	760 840 437	10	40					
32	760 840 439	10	40					

Body stop cock ④

20	760 840 426	10	40					
25	760 840 427	10	40					
32	760 840 428	10	40					

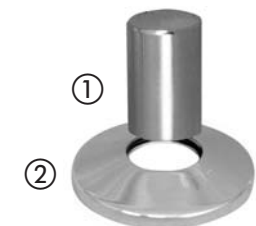

4056

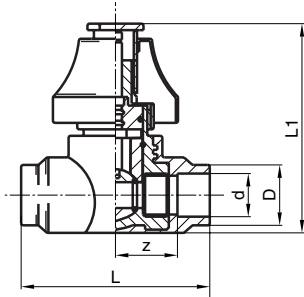

Ball valve

d	Code	SP	GP	g	D	L	z	L1
20	760 840 444	2	16	393	28	86	27	100
25	760 840 445	2	16	404	33	98	31	100

Covering tube and plate

	760 840 443		4					
--	-------------	--	---	--	--	--	--	--

Extension Kit

20/25	760 840 450		1					
-------	-------------	--	---	--	--	--	--	--

4056

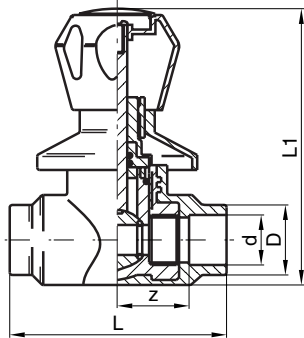

Ball valve with handle

d	Code	SP	GP	g	D	L	z	L1
20	760 840 447	2	16	511	28	86	27	105
25	760 840 448	2	16	522	33	98	31	105

Handle and covering tube and plate

	760 840 451		4					
--	-------------	--	---	--	--	--	--	--

Extension Kit

20/25	760 840 450		1					
-------	-------------	--	---	--	--	--	--	--

4096

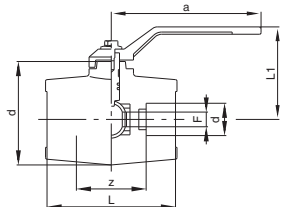

Ball valve with handle

d	Code	SP	GP	g	L	a	z	L1
20	760 840 792		25	115	67,5	102	38,5	60
25	760 840 793		20	135	70,5	102	38,5	60
32	760 840 794		15	190	79,5	102	43,5	63
40	760 840 795		8	350	94	119,5	54	78
50	760 840 796		6	510	109	119,5	63	83
63	760 840 797		3	935	130	146	78	103

4061

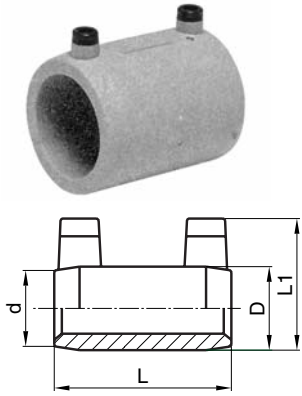

Electric socket

d	Code	SP	GP	g	D	L	L1
20	760 840 452	1	10	40	33	70	50
25	760 840 453	1	10	49	38	70	57
32	760 840 454	1	10	63	46	79	62
40	760 840 455	1	5	92	55	90	71
50	760 840 456	1	2	149	67	100	82
63	760 840 457	1	1	263	86	106	101
75	760 840 458	1	1	320	103	121	115
90	760 840 459	1	1	475	121	131	134
110	760 840 460	1	1	765	142	142	156
125	760 840 461	1	1	1060	163	151	175

4083



Electrofusion welding machine

d	Code
20/110	760 840 680

- input voltage 220 V - 50 Hz
 - voltage: <48 V
 - electrical power: 1200 Watt
 On request: positioning tool for electrofusion

91 98 033



Pipe scraping tool

d	Code
	799 198 RM4

4105



Standard socket welder

d	Code		SP	GP	mod.
16/63	760 840 518			1	PF63R
16/63	760 840 519			1	PF63E

PF63R Socket welder with electromechanical temperature regulation
 PF63E Socket welder with electronic temperature regulation
 Power 600 Watt

4108

Standard socket welder

d	Code		SP	GP	mod.
16/110	760 840 521			1	PF110R

Power 1500 Watt - 230 volt

4110



Bench holder

d	Code		SP	GP	mod.
	760 840 524			1	PF63R PF63E

4118



Tool kit for PF63R/PF63E

d	Code		SP	GP	mod.
	760 840 533			1	PF63R - PF63E

4124



Complete socket welder

d	Code		SP	GP	mod.
20/25/32	760 840 540			1	VALPF63

- PF63E manual welding with electromechanical thermostat power 600 Watt
- Heating tools 20 - 25 - 32
- Bench and fork holder
- Empty box

4134

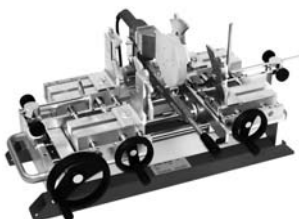

Electronic bench socket welding machine

d	Code		SP	GP	mod.
20/110	760 840 660			1	PB660

Set of heating tools

20/110	760 840 560				complete set
--------	-------------	--	--	--	--------------

Box packaging

	760 840 559				
--	-------------	--	--	--	--

PB660 1200W - 230V with electronic socket welder

4145



Set of heating tools for welder

d	Code	SP	GP
20	760 840 562	1m+1f	1m+1f
25	760 840 563	1m+1f	1m+1f
32	760 840 564	1m+1f	1m+1f
40	760 840 565	1m+1f	1m+1f
50	760 840 566	1m+1f	1m+1f
63	760 840 567	1m+1f	1m+1f
75	760 840 568	1m+1f	1m+1f
90	760 840 569	1m+1f	1m+1f
110	760 840 570	1m+1f	1m+1f
125	760 840 571	1m+1f	1m+1f
Hole mender			
7,5	760 840 481	1m+1f	1m+1f
11,4	760 840 482	1m+1f	1m+1f

4145



Heating tools for saddle with spigot

d	Code	SP	GP
40-20-25-1/2	760 840 585F	1m+1f	1m+1f
50-20-25-1/2	760 840 586F	1m+1f	1m+1f
63-20-25-1/2	760 840 587F	1m+1f	1m+1f
75-20-25-1/2	760 840 588F	1m+1f	1m+1f
90-20-25-1/2	760 840 589F	1m+1f	1m+1f
110-20-25-1/2	760 840 590F	1m+1f	1m+1f
125-20-25-1/2	760 840 591F	1m+1f	1m+1f
50-32-40-3/4 -1	760 840 592F	1m+1f	1m+1f
63-32-40-3/4	760 840 593F	1m+1f	1m+1f
75-32-40-3/4 -1	760 840 594F	1m+1f	1m+1f
90-32-40-3/4 -1	760 840 595F	1m+1f	1m+1f
110-32-40-3/4 -1	760 840 596F	1m+1f	1m+1f
125-32-40-3/4 -1	760 840 597F	1m+1f	1m+1f
Milling cutter for saddles with spigot			
20-25-1/2	760 840 600F	1	1
32-3/4	760 840 601F	1	1

5310



Thermostatic pencil

Code	SP	GP
799 496 008	1	1
799 496 009	1	1

melting temperature 253°C
melting temperature 274°C

5320



Safety gloves

Code	SP	GP
761 066 799	1	1

4073



Cutting nippers

d	Code	SP	GP
20/32	760 840 484	1	1
20/75	760 840 486	1	1

4074



Pipe cutter

d	Code	SP	GP
20/75	760 840 505		1
50/110	760 840 506		1

4185



Chamfering and peeling tool for PP-R pipes

d	Code	SP	GP
20	760 840 822		1
25	760 840 823		1
32	760 840 824		1
40	760 840 825		1
50	760 840 826		1
63	760 840 827		1
75	760 840 828		1
90	760 840 829		1
110	760 840 830		1

Handle for chamfering

20/32	760 840 818		1
-------	-------------	--	---

Side handle

40/110	760 840 819		1
--------	-------------	--	---

27.060.000

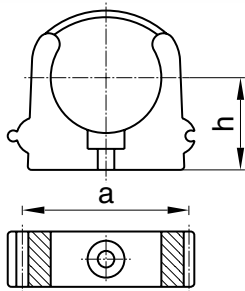

Pipe clamp

d	Code	SP	GP	g	a	h
20	167 061 006	10	200	8	36	25
25	167 061 007	10	200	10	41	27
32	167 061 008	10	200	13	51	31
40	167 061 009	10	150	23	62	35
50	167 061 010	10	140	32	72	40
63	167 061 011	10	80	45	88	52
75	167 061 012	10	60	62	102	58
90	167 061 013	10	-	91	123	70
110	167 061 014	10	-	123	146	80
125	167 061 015	10	-	174	176	90

4058



Plan test plug

d	Code	SP	GP	colour
1/2	760 840 512		100	blue
1/2	760 840 513		100	red

Complete of o-ring

Legend: D : outside diameter of the pipe
 SP : pieces for plastic bag
 GP : pieces for box
 R : taper external thread
 d: inside diameter
 Rp : parallel internal thread
 g : gram
 L : length
 z : dimension after welding

12. Standards and approvals

EN ISO 15874	Plastics piping systems for hot and cold water installations - PP
DIN 8077	PP pipes - sizes
DIN 8078	PP pipes - quality assurance standards
DIN 16962	PP pipes and fittings for pressure pipings
DIN 2999	Fittings with threaded metal insert
DIN 1988	Standards for drinking water plants
DIN 4109	Standards for piping noise reduction
DIN 8076	Metal insert fittings
DVS 2207	Welding regulations for thermoplastic materials
DVS 2208	Machines and equipment for thermoplastic welding
DIN 16887	Under pressure long time operating
DWG-GKR	Organolettic qualifications
ÖNORM B 5014	Tests for materials normally in contact with drinking water
DM174	Ministerial paper.

Product certification AQUASYSTEM

	AENOR	Asociación Española de Normalización y Certificación (Spain). Certificado N° 001/002980
	LNEC	Laboratório Nacional de Engenharia Civil. Departamento de Materiais de Construção (Portugal). DH 602
	KIWA	Technical Approval with Product Certificate K 12023/03
	CSTB	Hydraulique & Équipements Sanitaires (France). ATEC 14/04 - 899 CSTBat 73/74 - 899
	RINA	Registro Italiano Navale (Italy). N° MAC/288004 CS
	Lloyd's Register	LR Type Approval Certificate n° 01/00100 (E1)
	AR	Comisia de Agreement Tehnic in Constructii (Romania). 002 - 05/137 - 1998
		Ministry of Electricity & Water (Kuwait). 211-1998
	ABS	Certificate of design assessment n° 04-GE428472-PDA, 15/10/2004 Certificate of Manufacturing Assessment B0820650-TA 19/04/2007
	DNV	Type approval certificate n° K-2688, 14/03/2005
	Germanischer LLoyd	Type approval certificate n° 43348 - 02 HH
	BV	Type approval certificate n° 20335/AO BV



Partner for progress

Number	K12023/05	Replaces	K12023/02
Issued	2006-01-01	Dated	2000-11-01

**Technical approval-with-product certificate
PPR AQUASYSTEM**

Based on pre-certification tests as well as periodic inspections by Kiwa, the products referred to in this certificate and marked with the Kiwa-mark as indicated under 'marking', manufactured by

Georg Fischer S.p.A.

may, on delivery, be relied upon to comply with the Kiwa Evaluation Guideline BRL-K536 part B "Plastics piping systems of PP-R, intended for the transport of cold and heated drinking water".

Kiwa N.V.

ing. B. Meekma
Director
Certification and Inspection

This certificate is issued in accordance with the Kiwa Regulations for Product Certification.
This certificate consists of 3 pages.
Publication of the certificate is allowed.

<p>Company Georg Fischer S.p.A. Via Sondrio 1 I-20063 Cernusco s/N (MI) Italy Telephone +39 02 923361 Telefax +39 02 9233765</p>	<p>Representative Georg Fischer N.V. Lange Veenweg 19 P.O. Box 35 8340 AA Epe The Netherlands Telephone +31 576 67 82 22 Telefax +31 576 62 17 68</p>	<p>Kiwa N.V. Certification and Inspection St. W. Churchplein 273 P.O. Box 70 2200 AB Rijswijk The Netherlands Telephone +31 70 41 44 400 Telefax +31 70 41 44 420 Internet www.kiwa.nl</p>
-----------------------------------------------------------------------------------------------------------------------------------------------------------------	------------------------------------------------------------------------------------------------------------------------------------------------------------------------------------------	-----------------------------------------------------------------------------------------------------------------------------------------------------------------------------------------------------------------------------------



AENOR Asociación Española de Normalización y Certificación

CERTIFICADO AENOR DE PRODUCTO N° 001 / 002980
AENOR PRODUCT CERTIFICATE N°

La Asociación Española de Normalización y Certificación (AENOR) certifica que el producto
The Spanish Association for Standardisation and Certification (AENOR) certifies that the product

**TUBOS DE POLIPROPILENO (PP-R)
PARA INSTALACIONES DE AGUA CALIENTE Y FRÍA**

POLYPROPYLENE (PP-R) PIPES FOR HOT AND COLD WATER INSTALLATIONS

MARCA COMERCIAL: GEORG FISCHER PP-R
TRADEMARK:

SERIE	DIÁMETROS (mm)	CLASE DE APLICACIÓN / PRESIÓN DE DISEÑO (bar)	OPACIDAD
SERIE	DIAMETERS (mm)	APPLICATION CLASS / DESIGN PRESSURE (bar)	OPACITY
	2.5 20 - 25 - 32 - 40 - 50 - 63 - 75 - 90	1/10; 2/8; 4/10; 5/6	SI

suministrado por supplied by

GEORG FISCHER, S.A.
CL. ALCALA, 85 - 2° 28009 MADRID (ESPAÑA)

elaborado en and manufactured in

**DALMINE RESINE, S.p.A. - ZONA INDUSTRIALE FRESAGRANDINARIA
CHIETI (ITALIA)**

es conforme con complies with

**UNE-EN ISO 15874-1:2004
UNE-EN ISO 15874-2:2004**

Para conceder este Certificado, AENOR ha examinado el producto y ha comprobado el sistema de calidad aplicado para su elaboración. AENOR realiza estas actividades periódicamente mientras el Certificado no haya sido anulado, según se establece en el Reglamento Particular RP 01.52.

In order to grant this Certificate, AENOR has tested the product and has verified the quality system used in its manufacture. AENOR performs these tasks periodically while the Certificate has not been cancelled, in accordance with the stipulations of the Specific Rules RP 01.52.

Fecha de concesión: **2004-07-27** Fecha de renovación: **2006-06-07** Fecha de caducidad: **2011-06-07**
First issued on: Renewed on: Expires on:



Director General de AENOR
General Manager

No está autorizada la reproducción parcial de este documento. The partial reproduction of this document is not permitted.

AENOR - GÓNOVA, 6 - 28004 MADRID - Teléfono 914 32 60 00 - Telefax 913 10 46 83

DH 602

CISB Inté (Ajs)

CDU ISSN

MES - LABORATÓRIO NACIONAL DE ENGENHARIA CIVIL - PORTUGAL
HOMOLOGAÇÃO DE NOVOS MATERIAIS E PROCESSOS DE CONSTRUÇÃO
DOCUMENTO DE HOMOLOGAÇÃO

GEORG FISCHER

CARACTERÍSTICAS E CONDIÇÕES DE EMPREGO
EM SISTEMAS DE DISTRIBUIÇÃO DE ÁGUA QUENTE E FRÍA E DE AQUECIMENTO

JANEIRO DE 2000

HOMOLOGAÇÃO COM CERTIFICAÇÃO

O presente Documento anula e substitui o DH 485
A situação de validade do DH pode ser verificada por pedido dirigido ao LNEC ou por consulta da lista dos Documentos de Homologação válidos, acessível pela Internet.

DECISÃO DE HOMOLOGAÇÃO

O presente Documento de Homologação (DH) é elaborado ao abrigo do artigo 17º do Regulamento Geral das Edificações Urbanas (RGEU) - Decreto Nº 38 382, de 7 de Agosto de 1951, e posteriores alterações, - e dos despachos ministeriais referidos no capítulo 3. Define as características e estabelece as condições de utilização, em canalizações de distribuição de água quente e fria e de aquecimento do sistema com a designação GEORG FISCHER.

Esta homologação reconhece às empresas capacitadas para produzir tubos e acessórios com as características descritas no presente documento e é concedida no pressuposto que são integralmente cumpridas as prescrições contidas no DH.

Os materiais constituintes dos tubos e dos acessórios não devem pôr em risco a potabilidade da água, como estabelece o n.º 2 do artigo 85º do Regulamento Geral dos Sistemas Públicos e Prediais de Distribuição de Água e de Drenagem de Águas Residuais - Decreto Regulamentar n.º 23/95, de 23 de Agosto de 1995.

A presente homologação, por se tratar de uma Homologação com Certificação, é concedida sob condição das empresas manterem permanentemente um controlo interno de qualidade da produção e de se submeter a um controlo externo periódico pelo LNEC, permanecendo o DH válido enquanto forem satisfatórios os resultados destes dois controlos.

Lisboa e Laboratório Nacional de Engenharia Civil, em Janeiro de 2000.

O DIRECTOR

Rui M. Correia

LNEC / Departamento de Materiais de Construção
Av. Brasil, 101 / 1700-066 LISBOA - Portugal
Fax: +351 21 844 3023
Internet: <http://www.lnec.pt> 8000PUBLI@lneclnec.lnec.pt

CSTB
le futur en construction

Organisme certificateur

CERTIFICAT

Systèmes de canalisations de distribution d'eau

Décision n° 747-74-899 du 3 avril 2008
attachée à l'Avis Technique n° 14/04-899

Cette décision annule et remplace la décision n° 498-74-899 du 5 avril 2007

Sur proposition du comité d'évaluation, le produit :

Système+GF+AQUASYSTEM

De la société GEORG FISCHER SpA
Via Sondrio 1
IT - 20063 CERNUSCO s/n

Usine de IT - TESERO

bénéficie de la marque CSTBat en application des exigences générales de la certification CSTBat et du règlement technique n°15.1. Cette décision atteste que le produit ci-dessus est certifié conformément à ces référentiels.

CHAUFFAGE ET DISTRIBUTION SANITAIRE



La Direction Technique
Hervé BERGER

<p style="text-align: center;">CARACTÉRISTIQUES CERTIFIÉES</p> <p>Conformité à l'Avis Technique n°14/04-899 NATURE DU SYSTÈME: PPR</p> <p>Raccord PP-R</p> <ul style="list-style-type: none"> - Caractéristiques dimensionnelles - Indice de fluidité à chaud - Résistance à l'oxydation - Résistance à la pression 	<p>Ce certificat comporte 1 page. Correspondant à: Guy CALIN Tél. : 01 64 68 82 52 Fax : 01 64 68 84 44</p> <p>Si un retrait, suspension ou modification, le droit d'usage de ce certificat est révoqué sous 15 jours.</p> <p>Le site des certificats est tenu à jour au CSTB et disponible sur le site Internet www.cstb.fr.</p> <p>Quiconque présente ce certificat doit également produire en extenso l'Avis Technique correspondant.</p> 
---------------------------------------------------------------------------------------------------------------------------------------------------------------------------------------------------------------------------------------------------------------------------------------------------------------------------------------------------------------------------------	-------------------------------------------------------------------------------------------------------------------------------------------------------------------------------------------------------------------------------------------------------------------------------------------------------------------------------------------------------------------------------------------------------------------------------------------------------------------------------------------------------------------------------------------------------------------------------------

CENTRE SCIENTIFIQUE ET TECHNIQUE DU BATIMENT
SIÈGE SOCIAL - 84 AVENUE JEAN JAURES | CHAMPS-SUR-MARNE | 77447 MARNE-LE-VALLEE CEDEX 2
TEL. 00 33 01 64 68 82 82 | FAX. 00 33 01 64 68 79 17 | www.cstb.fr
MARNE-LE-VALLEE | PARIS | BRENOIS | WASTES | SUFFRIN-ANTIPOLIS

Agenzia Regionale per la Protezione dell'Ambiente della Lombardia
Laboratorio di Chimica Ambientale
 sede di Bergamo
 Via C. Maffei, n.4
 24121 Bergamo
 tel. 035-385815-Fax 035-385845

RAPPORTO DI PROVA

N° 86/RGA

CAMPIONE DI : Raccordo del sistema AQUASYSTEM in PPR
 PRESENTATO DA : Ditta GEORG FISCHER S.p.A.
 Via Sondrio, 1 Cernusco s/N (MI)
 IN DATA : 22/01/2001

DATI D'ANALISI

Il campione costituito da provino di Raccordo del sistema AQUASYSTEM in PPR tipo 3 - materia prima: POLIPROPILENE RANDOM, è stato sottoposto a contatto per 24 ore a 40°C con acqua distillata previo lavaggio con acqua corrente e successivo risciacquo rapido con acqua distillata.

Sul liquido sono state eseguite le seguenti determinazioni:

Migrazione globale 0,1 mg/dm² pari a 0,6ppm
Migrazione dei coloranti: Trasmissione ottica superiore al 95%
 (determinazione spettrofotometrica tra 400 e 750 nm)

La dichiarazione della composizione del prodotto è stata fondata dalla ditta GEORG FISCHER S.p.A. - Cernusco s/N (MI)

GIUDIZIO: Per le prove di migrazione globale e migrazione dei coloranti effettuate nelle condizioni di sperimentazione sopra descritte, il materiale è idoneo a venire a contatto con acqua potabile e/o da potabilizzare secondo i criteri stabiliti dalla Circolare Ministero della Sanità n. 102 del 02.12.78, salvo verifica della formula compositiva.

Bergamo, 02/02/2001

IL RESP. DELLA SEZ. ACQUE POTABILI
 Dr. Augusto Galli



IL RESP. DI CHIMICA AMBIENTALE
 Dr. Giacomo Galliani

Note:
 RGA: Registro Generali Analisi
 I risultati delle analisi si riferiscono esclusivamente al campione sottoposto a prova.
 Il presente rapporto di prova non può essere utilizzato a scopo pubblicitario o promozionale senza l'autorizzazione del Laboratorio di emissione.

Agenzia Regionale per la Protezione dell'Ambiente della Lombardia
Laboratorio di Chimica Ambientale
 sede di Bergamo
 Via C. Maffei, n.4
 24121 Bergamo
 tel. 035-385815-Fax 035-385845

RAPPORTO DI PROVA

N° 87/RGA

CAMPIONE DI : Tubo del sistema AQUASYSTEM in PPR
 PRESENTATO DA : Ditta GEORG FISCHER S.p.A.
 Via Sondrio, 1 Cernusco s/N (MI)
 IN DATA : 22/01/2001

DATI D'ANALISI

Il campione costituito da provino di Tubo del sistema AQUASYSTEM in PPR tipo 3 materia prima: POLIPROPILENE RANDOM, è stato sottoposto a contatto per 24 ore a 40°C con acqua distillata previo lavaggio con acqua corrente e successivo risciacquo rapido con acqua distillata.

Sul liquido sono state eseguite le seguenti determinazioni:

Migrazione globale 0,45 mg/dm² pari a 2,7 ppm
Migrazione dei coloranti: Trasmissione ottica superiore al 95%
 (determinazione spettrofotometrica tra 400 e 750 nm)

La dichiarazione della composizione del prodotto è stata fondata dalla ditta GEORG FISCHER S.p.A. - Cernusco s/N (MI)

GIUDIZIO: Per le prove di migrazione globale e migrazione dei coloranti effettuate nelle condizioni di sperimentazione sopra descritte, il materiale è idoneo a venire a contatto con acqua potabile e/o da potabilizzare secondo i criteri stabiliti dalla Circolare Ministero della Sanità n. 102 del 02.12.78, salvo verifica della formula compositiva.

Bergamo, 02/02/2001

IL RESP. DELLA SEZ. ACQUE POTABILI
 Dr. Augusto Galli



IL RESP. DI CHIMICA AMBIENTALE
 Dr. Giacomo Galliani

Note:
 RGA: Registro Generali Analisi
 I risultati delle analisi si riferiscono esclusivamente al campione sottoposto a prova.
 Il presente rapporto di prova non può essere utilizzato a scopo pubblicitario o promozionale senza l'autorizzazione del Laboratorio di emissione.



agrement tehnic 002 - 05/137 - 1998

Tevi din polipropilena reticulara pentru instalatii de alimentare cu apa calda si rece (TIP 3)

- **GEORG FISCHER + GF +** -
 Pipes of polypropylene random for water networks - (TIP 3) -
 GEORG FISCHER + GF +
 Tuyaux au polypropilene pour installations de l'eau - (TIP 3) -
 GEORG FISCHER + GF +

Titular : **CONSOL ROMANIA S.R.L.**
 Str. Trestiana nr. 9
 Tel.: 212.27.41
 Fax: 210.14.66
 BUCURESTI, ROMANIA

GEORG FISCHER + GF +
 Giorgio Fischer SpA, Via Sondrio no 1
 20063 Cernusco - Sul Naviglio - (MI)
 ITALY
 Tel: 0039 / 02 / 92186.227
 Fax: 0039 / 02 / 92140.785

Producator : **GEORG FISCHER + GF +**
 Giorgio Fischer SpA, Via Sondrio no 1
 20063 Cernusco - Sul Naviglio - (MI)
 ITALY
 Tel: 0039 / 02 / 92186.227
 Fax: 0039 / 02 / 92140.785

COMISIA DE AGREMENT TEHNIC IN CONSTRUCTII

LABORATORUL CENTRAL s.a. Bucuresti
 ROMANIA ; Bucuresti 2 ; Str. Barbu Vacarescu Nr.162 ; Tel. 230 42 58 ; Telefax 230 54 57 ; Telex 11706

Grupa specializata nr. 5 - produse pentru instalatii aferente constructiilor -

Prezentul Agrement Tehnic este valabil numai inotit de acord Comisiei de Agrement Tehnic in Constructii din ROMANIA



MINISTRY OF ELECTRICITY & WATER
WATER RESOURCES DEVELOPMENT CENTER
TOXICITY TEST OF NON-METALLIC MATERIALS

Material : P-P-R POLYPROPYLENE PIPES - GEORG FISCHER.
 Tested for : MUSTAFA AL - AYOUN TRADING COMPANY W.L.L.
 ref.n : 211 \ 1998
 Date received : 16 \ 9 \ 1998. Date out: 12 \ 10 \ 1998.

APPLICATION DETAILS:

P-P-R POLYPROPYLENE PIPES - GEORG FISCHER.
 applied by on
 cured for to be used in contact with potable water.

TEST DETAILS:

Physical and chemical results of the soaking test carried out on the samples for ten days for toxic metals and six days for organics in chlorinated potable water at 50°C are as follow :

- 1. Taste, odor or color :
- 2. PH value : WITHIN THE ALLOWABLE RANGE.
- 3. Release of T.O.C : WITHIN THE ALLOWABLE RANGE.
- 4. Release of toxic metals : WITHIN THE ALLOWABLE RANGE.
- 5. Release of T.H.M : WITHIN THE ALLOWABLE RANGE.
- 6. Release of phenols : WITHIN THE ALLOWABLE RANGE.
- 7. Release of other organics : WITHIN THE ALLOWABLE RANGE.

Based on the above results the tested material is suitable to be used in contact with drinking water under the surveillance condition of Kuwait (Water Quality & Temperature).

Note :- The results described in this report relate only to the samples submitted for evaluation.

-The Ministry of Electricity & Water is not responsible towards any changes in the specifications of the material.

OPERATOR
 Hanau Zahran

HEAD OF SECTION

DIRECTOR

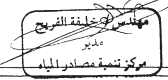

CERTIFICATO DI OMOLOGAZIONE DI TIPO
N. MAC28804CS



Si certifica che il seguente prodotto soddisfa le prescrizioni delle norme qui specificate.

Descrizione	Tubi e raccordi in plastica
Tipo	SISTEMA AQUASYSTEM
Richiedente	GEORG FISCHER SPA VIA SONDRIO 1 20063 CERNUSCO S/N (MI) ITALIA
Fabbricante	GEORG FISCHER SPA
Luogo di produzione	VIA SONDRIO 1 20063 CERNUSCO S/N (MI) ITALIA
Norme di riferimento	Parte C, Capitolo 1, Appendice 3 delle Norme RINA

Rilasciato a Genova il 2 Maggio 2005. Questo Certificato è valido fino al 2 Maggio 2010



 RINA
Giusto Migliardi

Questo Certificato è composto di 1 pagina e di 1 allegato

RINA Genova per azioni
Via Cavour, 12 - 10128 Genova
Tel. +39 010 53651
Fax +39 010 5361900



Type Approval Certificate Extension

This is to certify that Certificate No. 01/00100 for the undermoted products is extended and renumbered as shown.

This certificate is issued to:

PRODUCER	Georg Fischer SpA
PLACES OF PRODUCTION	Via Sondrio 1 20063 Cernusco s/N (MI) Italy
DESCRIPTION	PP-R (Random Polypropylene) piping system and fittings
TYPE	+GF+ Aquasystem
APPLICATION	Marine non-essential piping systems: Domestic hot and cold water services Heating and air conditioning systems Sanitary systems
SPECIFIED STANDARDS	Lloyd's Register's Rules and Regulations for the Classification of Ships Lloyd's Register's Rules and Regulations for the Classification of Special Service Craft EN ISO 15874 ASTM D635.91
RATINGS	Pipe diameter: 20mm to 110mm Pressure rating: PN10 and PN20 Temperature range: 0°C to 95°C

 D.J. Cox
 London Design Support Services
 Lloyd's Register EMEA

Certificate No.	01/00100(EI)
Issue Date	3 November 2006
Expiry Date	11 June 2011
Sheet	1 of 2

Lloyd's Register EMEA
71 Fenchurch Street, London EC3M 4BS

Lloyd's Register, its affiliates and subsidiaries and their respective officers, employees or agents are, individually and collectively, referred to in this clause as the "Lloyd's Register Group". The Lloyd's Register Group assumes no responsibility and shall not be liable to any person for any loss, damage or expense caused by reliance on the information or advice in this document or otherwise provided, unless that person has signed a contract with the relevant Lloyd's Register Group entity for the provision of this information or advice and in that case any responsibility or liability is exclusively on the terms and conditions set out in that contract.

Renewal in progress



CERTIFICATE NUMBER	04-GE428472-PDA	DATE	15 October 2004
ABS TECHNICAL OFFICE	Genoa Engineering Services		

CERTIFICATE OF Design Assessment

This is to Certify that a representative of this Bureau did, at the request of **Georg Fischer SpA - Società del Gruppo G. Fischer** assess design plans and data for the below listed product. This assessment is a representation by the Bureau as to the degree of compliance the design exhibits with applicable sections of the Rules. This assessment does not waive unit certification or classification procedures required by ABS Rules for products to be installed in ABS classed vessels or facilities. This certificate, by itself, does not reflect that the product is Type Approved. The scope and limitations of this assessment are detailed on the pages attached to this certificate. It will remain valid for five years from the date of issue or until the Rules or specifications used in the assessment are revised (whichever occurs first).

PRODUCT:	Plastic Pipes, Fittings and Valves
MODEL:	+GF+ AQUASYSTEM
ABS RULE:	2004 Steel Vessel Rules 1-1-403.7, 4-6-3/5
OTHER STANDARD:	

 AMERICAN BUREAU OF SHIPPING
 Luigi Trevisan
 Engineering Type Approval Co-ordinator

NOTE: This certificate evidences compliance with one or more of the Rules, Guides, standards or other criteria of American Bureau of Shipping or a statutory, industrial or manufacturer's standard and is issued solely for the use of the Bureau, its committees, its clients, or other authorized entities. This certificate is governed by the terms and conditions on the reverse side hereof.



CERTIFICATE NUMBER	BO820650-TA
PLANT LOCATION	Frade S.r. I. Tesero - (Trento), Italy
ABS OFFICE	Bergamo, Italy

CERTIFICATE OF Manufacturing Assessment

This is to Certify that a representative of this Bureau did, at the request of **Georg Fischer SpA**

Attend their facilities at the location noted above, in order to carry out an audit of their facilities and associated quality assurance and quality control procedures. The facility is considered capable of consistently manufacturing:

+GF+ AQUASYSTEM
PP-R (Polypropylene Random) pipes and fittings - Size 20 - 25 - 32 - 40 - 50 - 63 - 75 - 90 - 110 mm OD.

in compliance with their ABS Product Design Assessment Certificates and the designated standards defined therein. The product listed on their current Product Design Assessment Certificates are eligible to be placed on this Bureau's *List of Type Approved Products*, subject to annual facility audits by a representative of this Bureau, and renewal of this Certificate after five (5) years.

ISSUE DATE	19-Apr-07	EXPIRATION DATE	18-Apr-12
SURVEYOR'S SIGNATURE	 Franco Cimmino		
FIRST ANNUAL ENDORSEMENT	_____	Date:	_____
SECOND ANNUAL ENDORSEMENT	_____	Date:	_____
THIRD ANNUAL ENDORSEMENT	_____	Date:	_____
FOURTH ANNUAL ENDORSEMENT	_____	Date:	_____

AB257 (03-04)

Note: This certificate evidences compliance with one or more of the Rules, Guides, standards, or other criteria of American Bureau of Shipping; or a statutory, industrial, or manufacturer's standard, and is issued solely for the use of the Bureau, its committees, its clients, or other authorized entities. This certificate is governed by the terms and conditions on the reverse side hereof.



DET NORSKE VERITAS

TYPE APPROVAL CERTIFICATE

CERTIFICATE NO. K-2688
 This Certificate consists of 3 pages

This is to certify that the
Plastic Pipes, Thermoplastic
with type designation(s)
+GF+ AQUASYSTEM (PP-R Pipes and Fittings)
Manufactured by
Georg Fischer S.p.A.
(at Dalmine Resine S.p.A., Italy)
Cernusco S/N (MI), Italy

is found to comply with
 Det Norske Veritas' Rules for Classification of Ships

Application
 Non-essential systems for hot and cold fresh and seawater up to 10 and 20 bar. Service temp. 0°C to 70°C. Low Flame spread tested acc. to ASTM D635. The piping system is not tested w.r.t. Fire Endurance.

Place and date
Høvik, 2005-03-14
for DET NORSKE VERITAS AS



John Olav Nøkleby
Head of Section



This Certificate is valid until
2009-06-30



Gisle Hersvik
Surveyor

Local Office
DNV Milin

Notice: This Certificate is subject to terms and conditions overleaf. Any significant change in design or construction may render this Certificate invalid. The validity date relates to the Type Approval Certificate and not to the approval of equipment/systems installed.

If any other address than the address which is printed to have been received by any consignee or addressee of Det Norske Veritas, then Det Norske Veritas shall not be responsible for its printed name on or through. However, the consignee shall not exceed an amount equal to the amount for the services provided. Provided that the maximum compensation shall never exceed 100 000 dollars in the event of the loss of the original certificate. The holder shall make the Provision for Marine Rules as well as all other applicable rules, regulations, agreements and any other rules on board of the vessel.

DET NORSKE VERITAS AS VERITASVEIEN 1, 1322 HØVIK, NORWAY TEL: (+47) 67 57 69 00 FAX: (+47) 67 57 69 11
 Form No.: 20 00a Issue: January 98 Page 1 of 3



Our Ref: RWM5340

07/02/2008

Georg Fischer Sales Ltd,
Paradise Way,
Coventry,
CV2 2ST

Dear Sir

WATER REGULATIONS ADVISORY SCHEME
"ITEMS WHICH HAVE PASSED FULL TESTS OF EFFECT ON WATER QUALITY - BS 6920"

We refer to your application for the material(s) described below to be approved arising from the results of the tests of effect on water quality that have been carried out on the product(s) so described. It has been decided that there is no objection to its/their use provided the source, nature and manufacturing processes of the ingredients and products are not changed. (See notes overleaf).

POLYPROPYLENE - COMPONENTS 5260

Aquasystem PP-R. Beige coloured socket, elbow and tee. For cold water use only.

Test Report: M 104178/A, B & C

0801500 **GEORGE FISCHER SALES LTD**

An entry, as above, will accordingly be included in the Water Fittings Directory on-line, Part Two, under the section headed, "Materials which have passed full tests of effect on water quality".

Your attention is drawn to the statement overleaf. Manufacturers or applicants may only quote in their sales literature terms which are used in this letter, namely that the product as listed, having passed the tests of effect on water quality, is suitable for use in contact with potable water and that a reference to the product will be included in the Materials section, Part Two, of the Water Fittings Directory on-line; this may be abbreviated to "Water Regulations Advisory Scheme - Approved Material" or "WRAS - Approved Material". **Approval of this product does not signify the approval of its mechanical or physical properties for any use.**

The Technical Committee of the Scheme reserves the right to review approval. This product automatically becomes due for audit/reassessment in January 2013.

Yours faithfully

 Rebecca Williams
 Materials Approval
 Water Regulations Advisory Scheme

Water Regulations Advisory Scheme
 20 Park Close, Park - Fen Industrial Estate,
 Oakdale, Ower, NP11 3BJ, UK.
 Tel: 01495 249454. Fax: 01495 249231.
 E-mail: info@wras.co.uk Website: www.wras.co.uk

Type Approval Certificate



Germanischer Lloyd

This is to certify that the undernoted product(s) has/have been tested in accordance with the relevant requirements of the GL Type Approval System.

Certificate No.	43 348 - 02 HH
Company	Georg Fischer spa. V. Sondrio 1 20063 Cernusco S/N (MI), ITALY
Product Description	THERMOPLASTIC PIPES AND FITTINGS
Type	+GF+ AQUASYSTEM PP-R piping system
Environmental Category	None
Technical Data / Range of Application	TECHNICAL DATA Size range: 20 [mm] O.D. to 110 [mm] O.D. Maximum allowable working pressure: 8 [bar], 16 [bar] Temperature range 0 [°C] up to 95 [°C] [Reduction of maximum allowable working pressure by service temperature above 20°C according to the specification of the manufacturer.] RANGE OF APPLICATION: Hot and cold potable water, sanitary discharge and drain and heating systems according to IMO Res. 753 (18), Appendix 4, arranged within accommodation, service- and control spaces, cofferdams, void spaces, pipe tunnels and ducts and further locations where fire endurance test according to the IMO Res. A.753 (18) is not required. LIMITATION The piping system is not approved for installation within tanks and open decks. INSTALLATION Refer to page 2
Test Standard	• IMO Resolution A.753 (18); 1993, except fire endurance, toxicity, and smoke generation test. Flame spread test acc. to ASTM D 635
Documents	• Test reports • Catalogue GF/173/1106) 3000 Chiesa
Remarks	For the use on passenger vessels national authority requirements may have to be observed.
Valid until	2012-10-10
Page	1 of 2
File No.	ILC.04
Hamburg, 2007-05-31	

Type Approval Symbol 

 Günther Hölzer Hagen Markus

Germanischer Lloyd

This certificate is issued on the basis of "Guidelines for the Performance of Type Approvals Part 1, Procedures".

MARINE DIVISION
 17 bis Place des Roflets - La Défense 2
 92400 Courbevoie - France
 Tel. 33 1 42 91 52 91
 Fax. 33 1 42 91 28 94
 www.veritas.com

Certificate number: 20335/A0 BV
 File number : ACM 135/266001
 Product code : 2080H

This certificate is not valid when presented without the full attached schedule comprised of 7 sections



TYPE APPROVAL CERTIFICATE

as per Bureau Veritas Classification Rules

This certificate is issued to

GEORG FISHER SPA
 Cernusco S/Naviglio (MI) - ITALY

for the type of product

THERMOPLASTIC MATERIAL PIPES AND FITTINGS
 +GF+ AQUASYSTEM PP-R Pipes and Fittings

Regulations and standards :
 - BUREAU VERITAS Rules for the Classification of Steel Ships
 - BUREAU VERITAS Rules for the Classification of Offshore Units
 - FTP Code, Resolution MSC.61(67), IMO Resolution A.753(18)

This certificate is issued to attest that BUREAU VERITAS did undertake the relevant approval procedures for the product identified above which was found to comply with the relevant requirements of the Regulations and standards mentioned above.

This certificate is valid until : 17 Apr 2013

At Paris la Défense, on : 17 Apr 2008

For BUREAU VERITAS,
By order of the Secretary

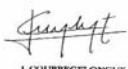
 L. HINGELONGUE

Approval office



Local office : BV GENOA
 Surveyor : C. Bozzetti



This certificate remains valid until the date stated above, unless cancelled or revoked, provided the conditions indicated in the subsequent page(s) are complied with and the product remains satisfactory in service. This certificate will not be valid if the applicant makes any changes or modifications to the approved product, which have not been notified to, and signed in writing with BUREAU VERITAS. Should the specified regulations or standards be amended during the validity of this certificate, the product(s) liable to be re-approved prior to being placed on board vessels to which the amended regulations or standards apply. This certificate is issued within the scope of the General Conditions of BUREAU VERITAS Marine Division. Any person not a party to the contract pursuant to which this document is delivered may not assert a claim against BUREAU VERITAS for any liability arising out of errors or omissions which may be contained in said document, or for errors of judgment, fault or negligence committed by personnel of the Society or of its Agents in establishment or issuance of this document, and in connection with any activities for which it may provide.

BV mod. Ad.E 530 August 2005 This certificate consists of 3 pages

50

+GF+



Georg Fischer S.p.A.
Via Sondrio 1 - 20063 Cernusco S/N (MI)
Tel. +39 02 921861 - Fax +39 02 92140785-6
it.ps@georgfischer.com
www.georgfischer.it